

# **USER MANUAL**

## **Hybrid**

### **Solar Inverter**

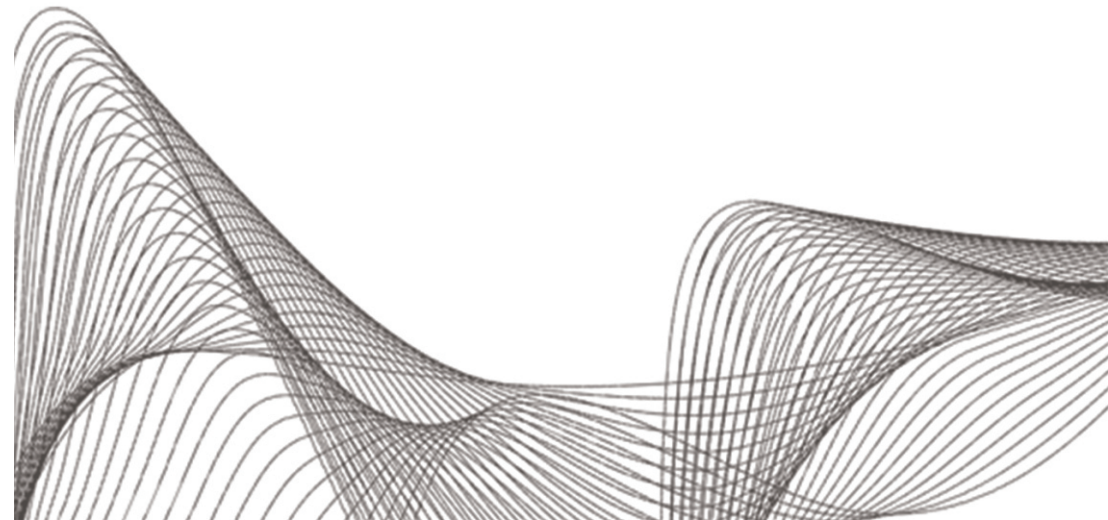

# Table Of Contents

<b>1 About This Manual</b> .....	<b>1</b>
1.1 Purpose.....	1
1.2 Scope.....	1
<b>2 Safety Instructions</b> .....	<b>1</b>
<b>3 Introduction</b> .....	<b>2</b>
3.1 Features.....	2
3.2 Basic System Architecture.....	2
3.3 Product Overview.....	3
<b>4 Installation</b> .....	<b>5</b>
4.1 Unpacking And Inspection .....	5
4.2 Preparation .....	6
4.3 Mounting The Unit.....	6
4.4 Battery Connection.....	7
4.5 Ac Input/Output Connection.....	8
4.6 PV Connection.....	9
4.7 Final Assembly.....	11
4.8 Communication Connection .....	11
<b>5 Operation</b> .....	<b>11</b>
5.1 Power On/off.....	11
5.2 Operation And Display Panel.....	12
5.3 Function setting operation.....	19
5.4 Battery Equalization Description.....	37
5.5 Fault and alarm description.....	38
<b>6 Trouble Shooting</b> .....	<b>41</b>
<b>7 Technical Datasheet</b> .....	<b>42</b>
<b>Appendix:Parallel Operation Guide</b> .....	<b>43</b>
<b>1. Parallel operation</b> .....	<b>43</b>
1.1 Single-phase parallel operation .....	43
1.2 Three-phase parallel operation.....	45
<b>2. Connection Precautions</b> .....	<b>50</b>
2.1 PV connection/Solar Panel Connection.....	50
2.2 Parallel board connection.....	50
<b>3. LCD Setup and Display</b> .....	<b>50</b>
3.1 Single-phase parallel.....	50
3.2. Parallel as three-phase system( the function is not open).....	52

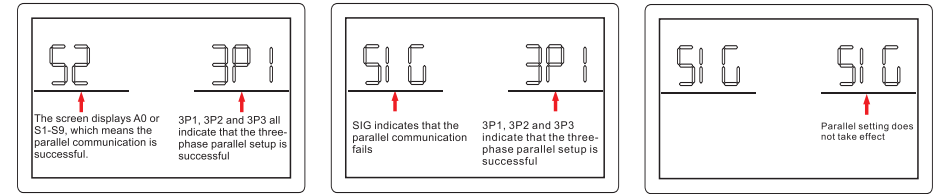

The parallel setting is successful, the communication is successful interface.      The parallel setting is successful, but the communication failure interface      Parallel setting failure interface

Figure 4.1.2

Note 1: To avoid overloading, it is best to let the whole system operate normally before closing the circuit breaker on the load side.

Note 2: There is a switching time for this power supply system. Power outages may occur for critical equipment with high power requirements.

### 3.2 Parallel as three-phase system (the function is not open)

Step 1: Before commissioning, please check the following requirements:  
Is the wiring correct?

Make sure that all circuit breakers on the load side are disconnected, and the neutral wires (N/neutral) of each inverter are connected together, the live wires (L wires) on the load side of the same phase are connected together, and the different phases are connected together. The live wires (L wires) are not connected together. Confirm that the output inverter voltage of each machine, the DC component and the battery voltage are all successfully calibrated.

Step 2: Wake up the inverter to put it into shutdown state, then use program 27 on the LCD to configure each Inverter as 3P1, 3P2, 3P3 in turn.

When using the LCD for program setting, the power-on switch must be turned off. Otherwise, settings cannot be made.

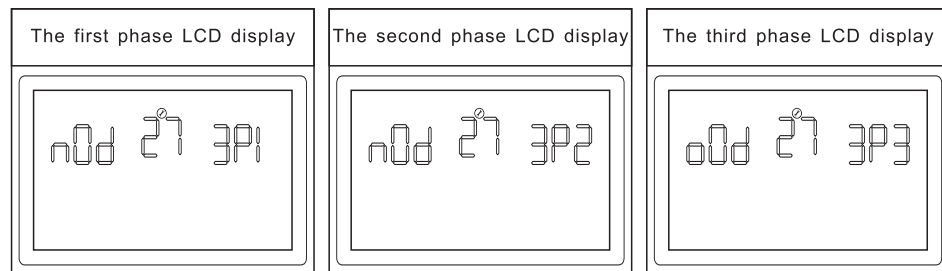

Step 3: Turn on the AC circuit breakers for all lines in the AC input. If an AC connection is detected and matches the device settings, the system is working properly. Otherwise, The system will display an alarm or fault, and will not operate in mains mode.

Step 4: Close the AC circuit breakers of all lines in the AC input, keep the rocker switch not closed, and wake up the parallel system. There are instructions on the next page of P9 on the LCD display interface, as shown in Figure 4.1.2, which means three-phase power supply System installation is complete.

Step 5: Please close the circuit breakers of all power lines on the load side, close the rocker switch, and the system will start supplying power to the load.

## 1 About This Manual

### 1.1 Purpose

This manual describes the assembly, installation, operation and troubleshooting of this unit. Please read this manual carefully before installations and operations, Keep manual for future reference.

### 1.2 Scope

This manual provides safety and installation guidelines as well as information on tools and wiring.

## 2 Safety Instructions



**WARNING: This chapter contains important safety and operating instructions. Read and keep this manual for future reference.**

1. Before using the unit read all instructions and cautionary markings on the unit, the batteries and all appropriate sections of this manual.
2. **CAUTION**-To reduce risk of injury, charge only deep-cycle lead acid type rechargeable batteries. Other types of batteries may burst, causing personal injury and damage.
3. Do not disassemble the unit Take it to a qualified service center when service or repair is required. Incorrect re-assembly may result in a risk of electric shock or fire.
4. To reduce risk of electric shock, disconnect all wirings before attempting any maintenance or cleaning. Turning off the unit will not reduce this risk.
5. **CAUTION**-Only qualified personnel can install this device with battery.
6. **NEVER** charge a frozen battery.
7. For optimum operation of this inverter/charger, please follow required spec to select appropriate cable size. It's very important to correctly operate this inverter/charger.
8. Be very cautious when working with metal tools on or around batteries. A potential risk exists to drop a tool to spark or short circuit batteries or other electrical parts and could cause an explosion.
9. Please strictly follow installation procedure when you want to disconnect AC or DC terminals, Please refer to INSTALLATION section of this manual for the details
10. One piece of 150A fuse is provided as over-current protection for the battery supply.
11. **GROUNDING INSTRUCTIONS** -This inverter/ charger should be connected to a permanent grounder wiring system. Be sure to comply with local requirements and regulation to install this inverter.
12. **NEVER** cause AC output and DC input short circuited. Do NOT connect to the mains when DC input short circuits.
13. **Warning!!** Only qualified service persons are able to service this device. If errors still persist after following troubleshooting table, please send this inverter/charger back to local dealer or service center for maintenance.

### 3 Introduction

This is a multi-function Inverter/charger, combining functions of inverter, solar charger and battery charger to offer uninterruptible power support with portable size. Its comprehensive LCD display offers user-configurable and easy-accessible button operation such as battery charging current, AC/solar charger priority, and acceptable input voltage based on different applications.

#### 3.1 Features

- ◆ Pure sine wave inverter
- ◆ Configurable input voltage range for home appliances and personal computers via LCD setting
- ◆ Configurable battery charging current based on applications via LCD setting
- ◆ Configurable AC/Solar Charger priority via LCD setting
- ◆ Compatible to mains voltage or generator power
- ◆ Auto restart while AC is recovering
- ◆ Overload/Over temperature/short circuit protection
- ◆ Smart battery charger design for optimized battery performance
- ◆ Cold start function

#### 3.2 Basic System Architecture

The following illustration shows basic application for this inverter/charger. It also includes following devices to have a complete running system:

- ◆ Generator or Utility
- ◆ PV modules

Consult with your system integrator for other possible system architectures depending on your requirements.

This inverter can power all kinds of appliances in home or environment, including motor-type appliances such as tube light, fan, refrigerator and air conditioner.

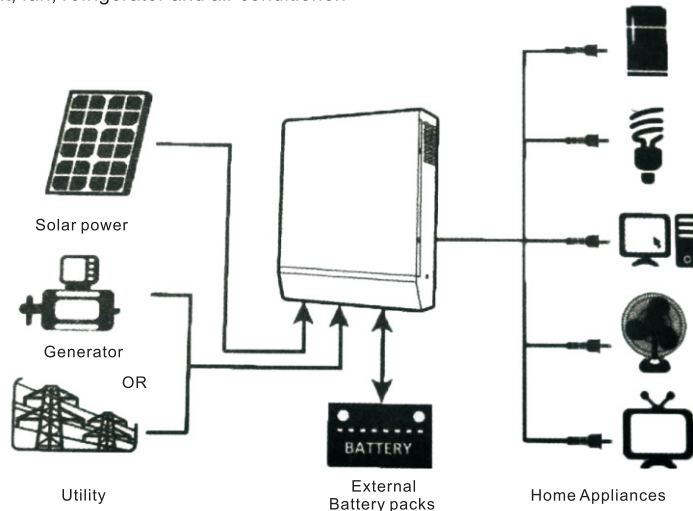

Make sure all circuit breakers in the load side line are open And each neutral line (N line) of the inverter is connected together, and the live line (L line) at the load side should also be connected together.

Step 2: Go into Inverter setting mode and set "PAR" in program 27 on the LCD. Then turn off all inverters.

Note: When setting on the LCD, the power-on switch must be turned off. Otherwise, settings cannot be made.

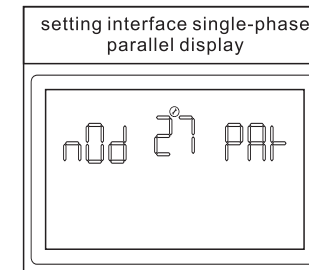

Notice: Automatic identification of primary and secondary inverters in the system

Step 3: Close the AC circuit breakers of all lines in the AC input, keep the rocker switch not closed, and wake up the parallel system. There are instructions on the next page of P9 on the LCD display interface, as shown in Figure 4.1.1. It is best to have all inverters connected to mains at the same time. If not, it will show fault 23 or 22.

Step 4: If there are no more fault alarms and the indicating interface is normal, the parallel system is fully installed.

Step 5: Close the circuit breaker on the load side. Turn on the system and start supplying power to the load.

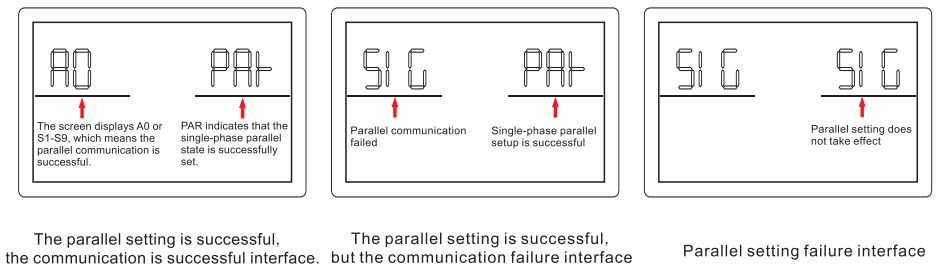

The parallel setting is successful, the communication is successful interface. The parallel setting is successful, but the communication failure interface. Parallel setting failure interface

Figure 4. 1. 1



## Communication Connection

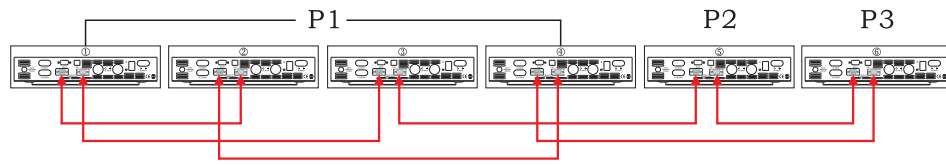

## 2. Connection Precautions

### 2.1 PV connection/Solar Panel Connection

Each inverter is connected to the solar panel separately, and the PVs of each inverter cannot be wired in parallel.

### 2.2 Parallel board connection

Note: In each set of parallel systems, select the two sets of machines with the farthest distance and short-circuit the positions A of the parallel board with jumper caps.

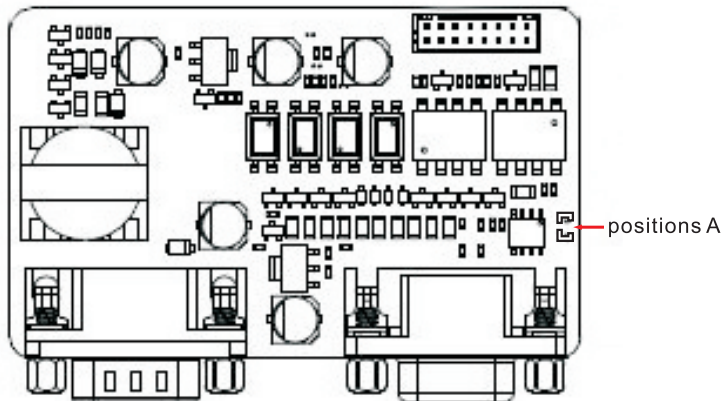

## 3. LCD Setup and Display

For the parallel setting operation, refer to the main manual - function setting operation, item 27 parallel mode setting.

### 3.1 Single-phase parallel

Step 1: Before commissioning, please check the following requirements:  
Is the wiring correct?

## 3.3 Product Overview

### 3.3.1 LCD Screen

#### Four Function Buttons:

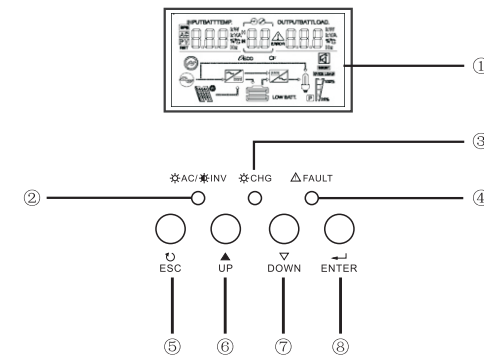

- |                          |             |
|--------------------------|-------------|
| 1.....LCD display        | 5.....ESC   |
| 2.....Status indicator   | 6.....UP    |
| 3.....Charging indicator | 7.....DOWN  |
| 4.....Fault indicator    | 8.....ENTER |

#### Three Function Buttons:

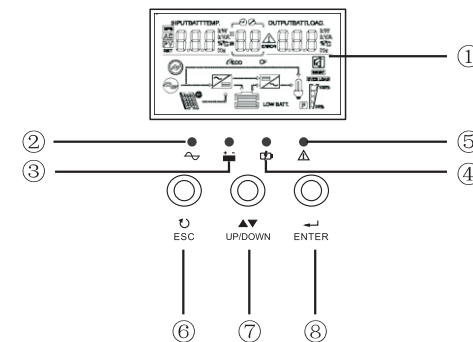

- |                               |                          |
|-------------------------------|--------------------------|
| ①.....LCD Display             | ⑤.....Alarming Indicator |
| ②.....AC Mode Indicator       | ⑥.....ESC                |
| ③.....Inverter Mode Indicator | ⑦.....UP/DOWN            |
| ④.....Charging Indicator      | ⑧.....ENTER              |

### 3.3.2 Back Panel

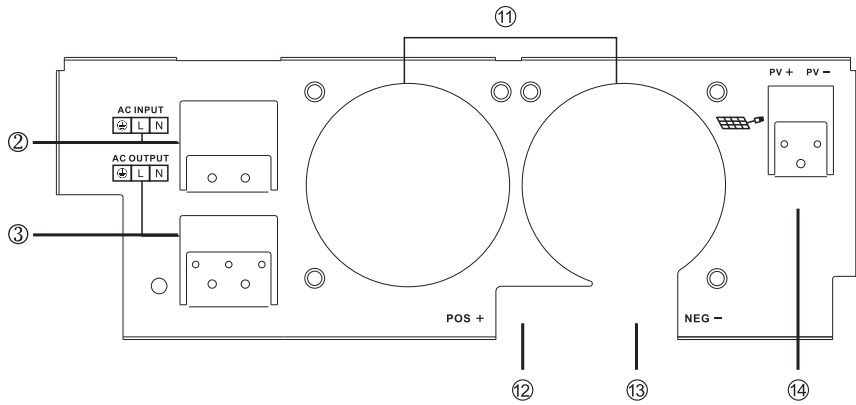
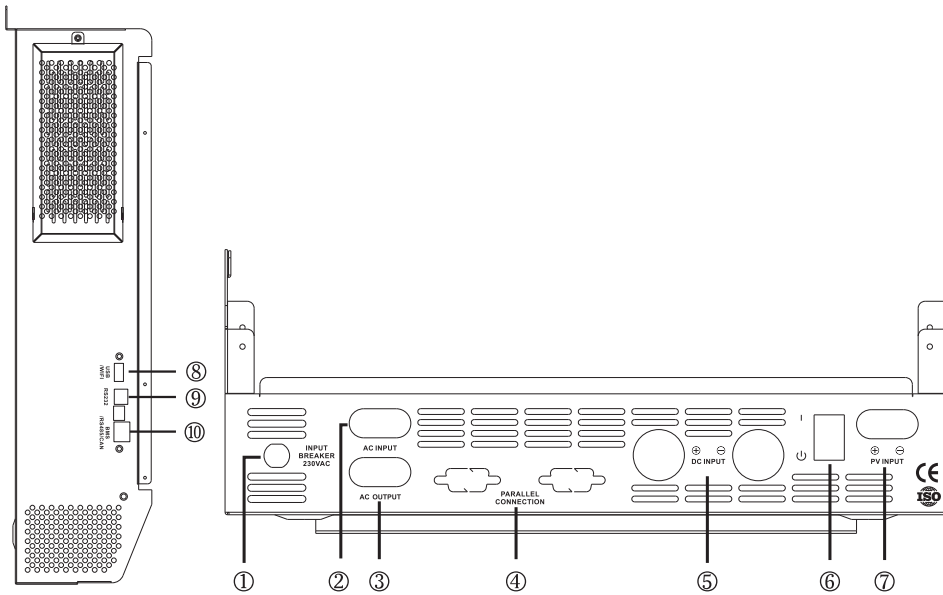

### BMS

- |                            |  |
|----------------------------|--|
| 1.....Input Breaker        | 8.....USB/WIFI Communication Port      |
| 2.....AC Input             | 9.....RS232 Communication Port         |
| 3.....AC Output            | 10....BMS/RS485/CAN Communication Port |
| 4.....Parallel Connection  | 11....Fan                              |
| 5.....Battery Input        | 12....Battery Terminal Positive        |
| 6.....Power ON/ OFF Switch | 13....Battery Terminal Negative        |
| 7.....PV Input             | 14.....Solar Panel Input               |

### 1.2.6 Three inverters for the first phase, two inverters for the second phase, and one inverter for the third phase:

#### System Connection

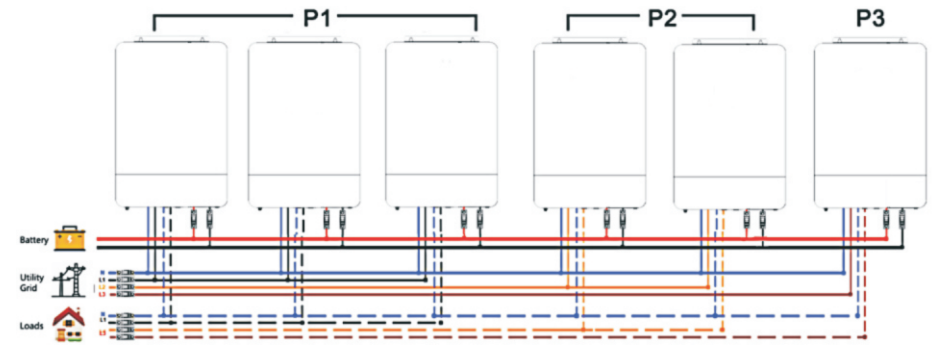

#### Communication Connection

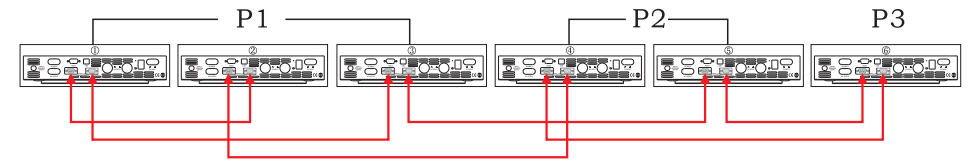

### 1.2.7 Four inverters for the first phase and one inverter for the other two phases:

#### System Connection

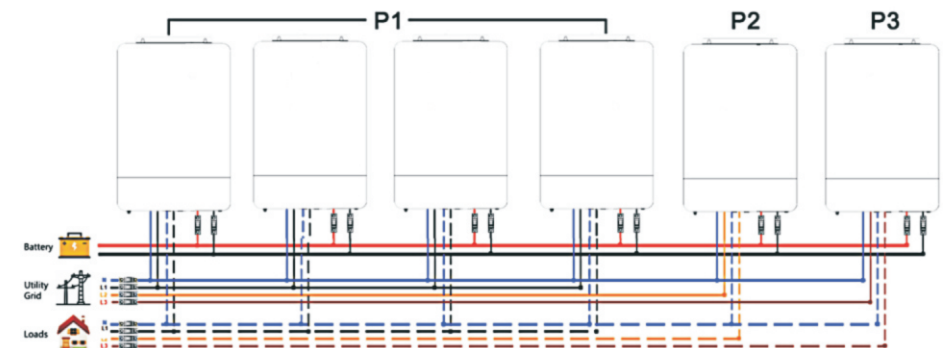

## Communication Connection

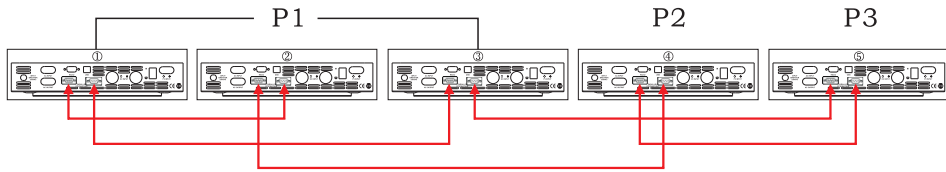

## 1.2.5 Two inverters per phase:

### System Connection

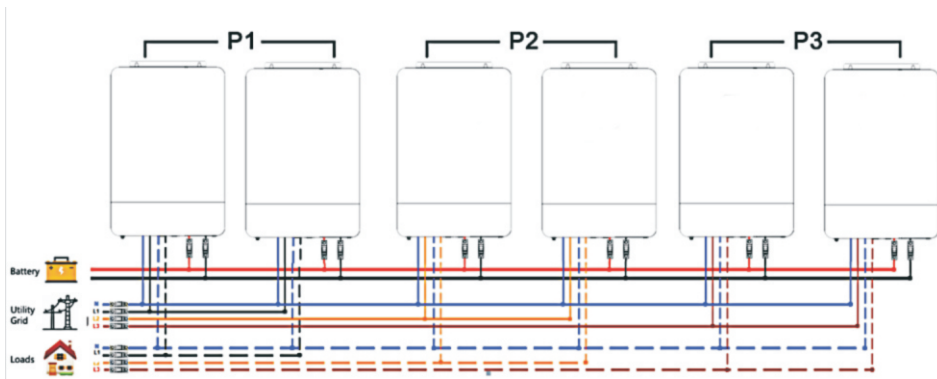

## Communication Connection

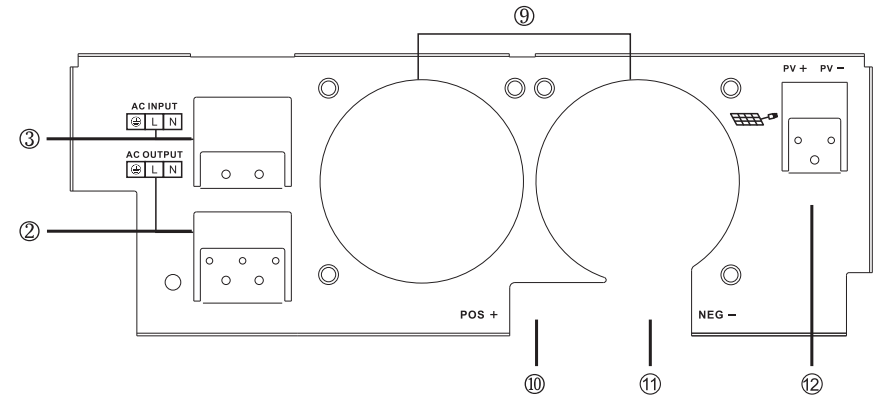
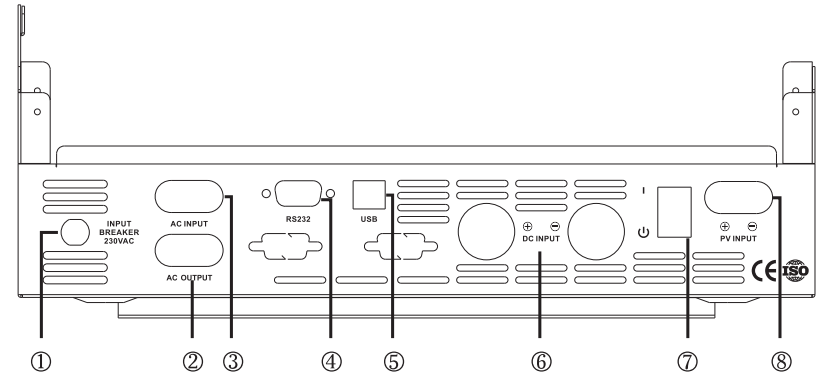
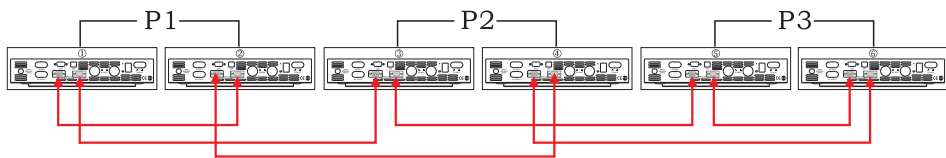

- |                                |                                |
|--------------------------------|--------------------------------|
| 1.....Input Breaker            | 7.....Power ON/OFF Switch      |
| 2.....AC Output                | 8.....PV Input                 |
| 3.....AC Input                 | 9.....Fan                      |
| 4.....RS232 Communication Port | 10...Battery Terminal Positive |
| 5.....USB Communication Port   | 11...Battery Terminal Negative |
| 6.....Battery Input            | 12...Solar Panel Input         |

## 4 INSTALLATION

### 4.1 Unpacking and Inspection

Before installation, please inspect the unit. Be sure that nothing inside the package is damaged. You should have received the following items inside of package:

- ◆ The unit x 1
- ◆ User manual 1

#### 4.2 Preparation

Before connecting all please take off bottom cover by removing two screws as shown below.

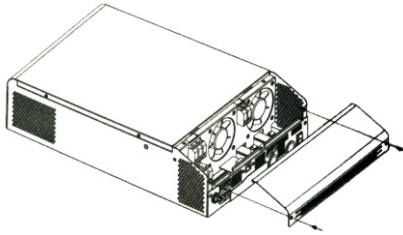

#### 4.3 Mounting the Unit

Consider the following points before selecting where to install:

- ※ Do not mount the inverter on flammable construction materials.
- ※ Mount on a solid surface
- ※ Install this inverter at eye level in order to allow the LCD display to be read at all times.
- ※ For proper air circulation to dissipate heat, allow a clearance of approx. 20 cm to the side and approx. 50 cm above and below the unit.
- ※ The ambient temperature should be between and to ensure optimal operation.
- ※ The recommended installation position is to be adhered to the wall vertically.
- ※ Be sure to keep other objects and surfaces as shown in the diagram to guarantee sufficient heat dissipation and to have enough space for removing wires.

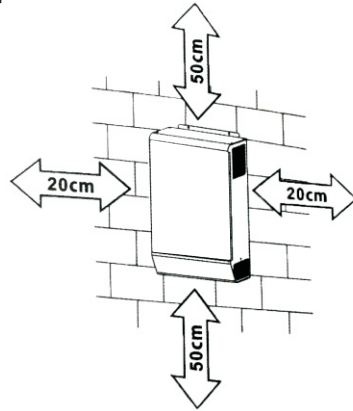

**⚠ SUITABLE FOR MOUNTING ON CONCRETE OR OTHER NON-COMBUSTIBLE SURFACE ONLY.**

Install the unit by screwing two screws.

- 1,2 Use the M6\*80mm expansion bolts.
- 3 Use M4 or M5.

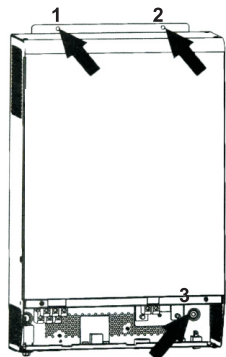

#### 1.2.3 Two inverters for the first and second phases, and one inverter for the third phase:

System Connection

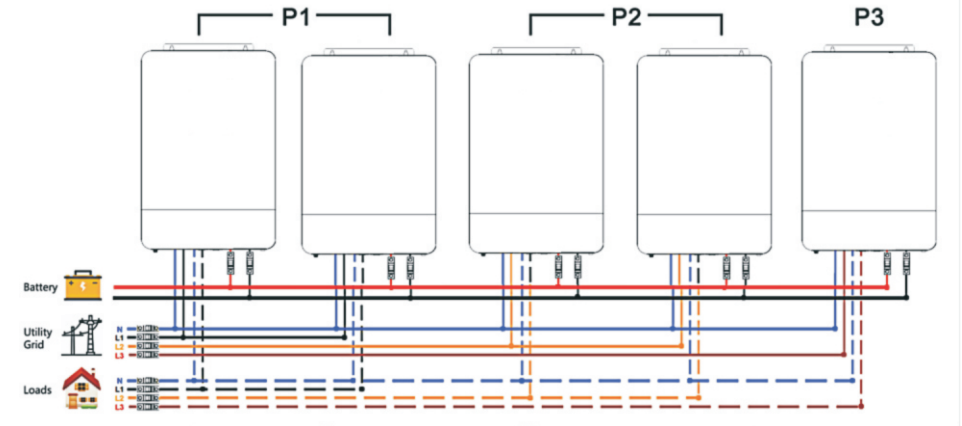

Communication Connection

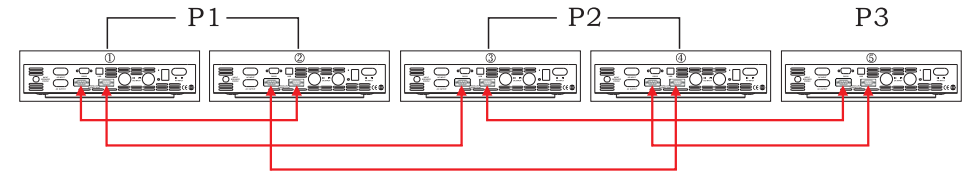

#### 1.2.4 Three inverters for the first phase, only one inverter for the other two phases

System Connection

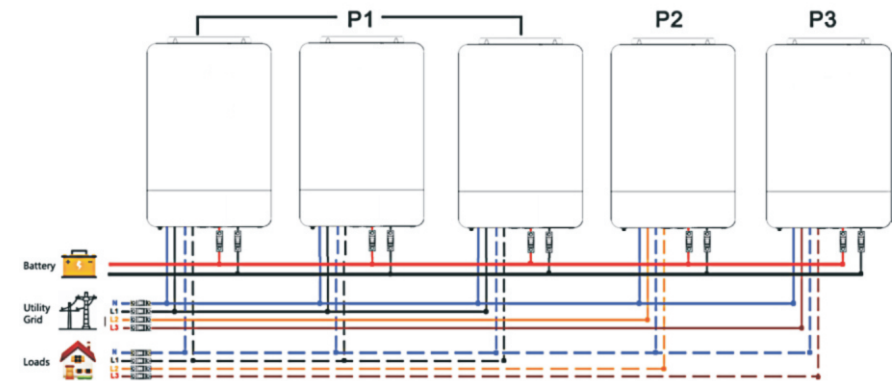

## 1.2.2 Two inverters for the first phase, only one inverter for the remaining phases:

### System Connection

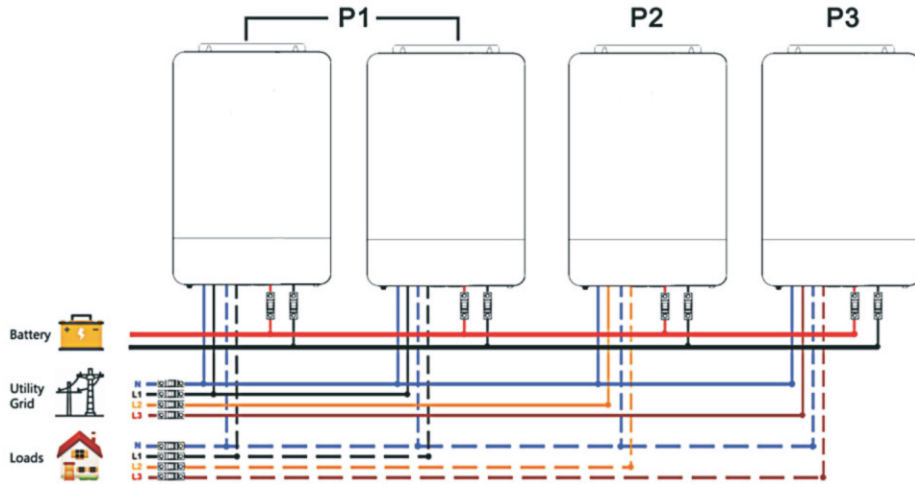

### Communication Connection

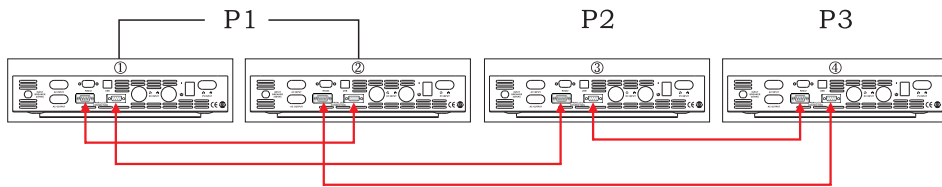

## 4.4 Battery Connection

**CAUTION:** For safety operation and regulation compliance, it's requested to install a separate DC over-current protector or disconnect device between battery and inverter. It may not be requested to have a disconnect device in some applications, however, it's still requested to over-current protection installed. Please refer to typical amperage in below table as required fuse or breaker size.

**WARNING!** All wiring must be performed by qualified personnel.  
**WARNING!** It's very important for system safety and efficient operation to use appropriate cable for battery connection. To reduce risk of injury, please use the proper recommended cable and terminal size as below.

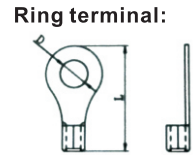

Recommended battery cable and terminal size:

Model	Typical Amperage	Battery capacity	Wire Size	Ring Terminal			Torque value
				Cable(mm <sup>2</sup> )	Dimensions		
					D(mm)	L(mm)	
1KVA/2KVA	44A/88A	100AH	1*6AWG	14	6.4	33.2	2~3 Nm
			2*10AWG	6	6.4	23.8	
3KVA	132A	100AH	1*4AWG	22	6.4	33.2	2~3 Nm
		200AH	2*8AWG	9	6.4	29.2	
3.5KVA	153A	200AH	1*2AWG	34	6.4	39.2	2~3 Nm
			2*6AWG	14	6.4	33.2	
5KVA	109A	200AH	1*2AWG	38	6.4	39.2	2~3 Nm
			2*6AWG	28	6.4	33.2	
5.5KVA	121A	200AH	1*2AWG	34	6.4	39.2	2~3 Nm
			2*6AWG	14	6.4	33.2	
10KVA	220A	200AH	2*3AWG	25	6.4	39.2	2~3 Nm
			4*7AWG	11	6.4	29.2	

please follow below steps to implement battery connection:

1. Assemble battery ring terminal based on recommended battery cable and terminal size.

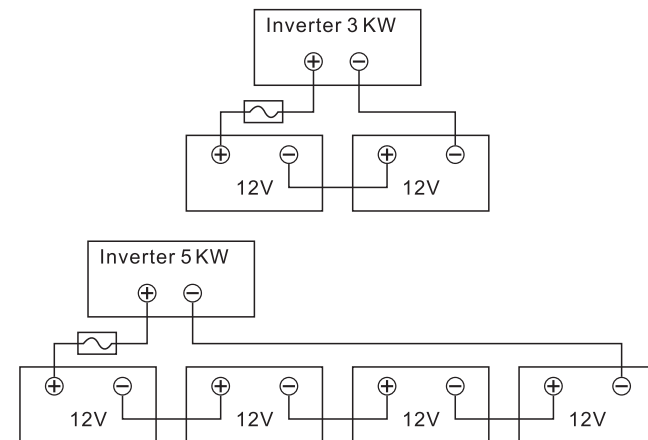

2. Insert the battery wires flatly into battery connectors of inverter and make sure the bolts are tightened with torque of 2 Nm in clockwise direction. Make sure polarity at both the battery and the inverter/charge is correctly connected and conductors are tightly screwed into the battery terminals. Recommended tool: # 2 Pozi Screwdriver

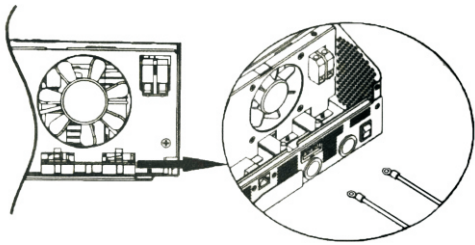

	<b>WARNING:</b> Shock Hazard Installation must be performed with care due to high battery voltage in series.
	<b>CAUTION!!</b> Before making the final DC connection or closing DC breaker/disconnector, be sure positive (+) must be connected to positive (+) and negative (-) must be connected to negative (-).

#### 4.5 AC Input Output Connection

**CAUTION!!** Before connecting to AC input power source, please Install a separate AC breaker between inverter and AC input power source. This will ensure the Inverter can be disconnected during maintenance and fully protected from over current of AC input. The recommended spec of breaker is 32A for 3 KW and 50A for 5 KW.

**CAUTION!!** There are two terminal blocks with " IN " and " OUT " markings. Please do NOT mis-connect input and output connectors.

**WARNING!** All wiring must be performed by qualified personnel.

**WARNING!** It's very important for system safety and efficient operation to use appropriate cable for AC input connection. To reduce risk of injury, please use the proper recommended cable size as below.

#### Suggested cable requirement for AC wires

Model	Gauge	Torque value
1KVA	16AWG	0.5~0.6Nm
2KVA	14AWG	0.8~1.0Nm
3KVA	12AWG	1.2~1.6Nm
3.5KVA	10AWG	1.2~1.6Nm
5KVA	8AWG	1.4~1.6Nm
5.5KVA	8AWG	1.6~1.8Nm
10KVA	6AWG	1.6~1.8Nm

Please follow below steps to implement AC input/ output connection

1. Before making AC input/output connection be sure to open DC protector or disconnecter first.
2. Remove insulation sleeve 10mm for six conductors. And shorten phase L and neutral conductor N 3 mm.

## 1.2 Three-phase parallel operation

### 1.2.1 One inverter per phase:

System Connection

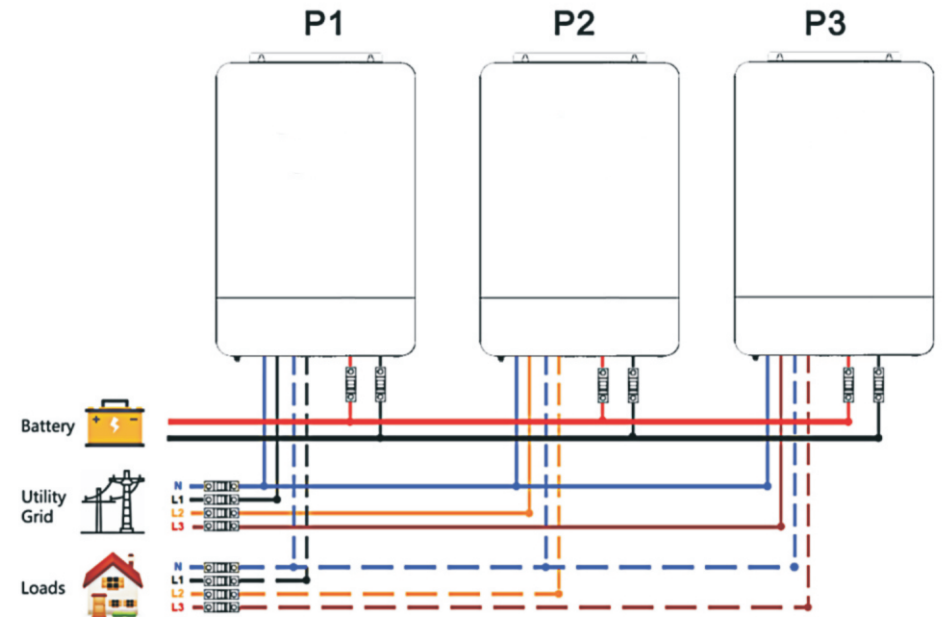

Communication Connection

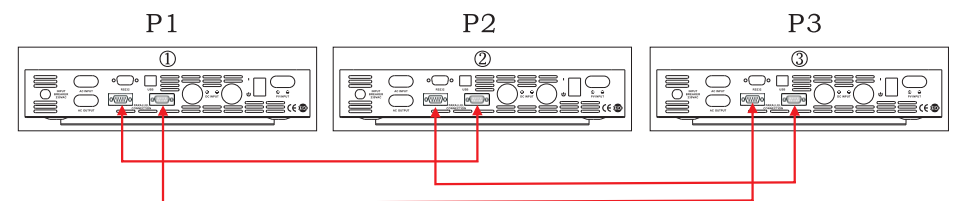



## Communication Connection

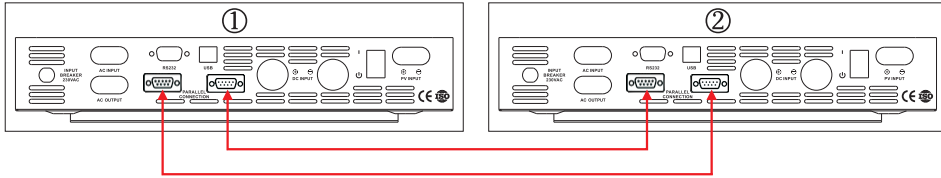

### 1.1.2 Three inverters in parallel

#### System Connection

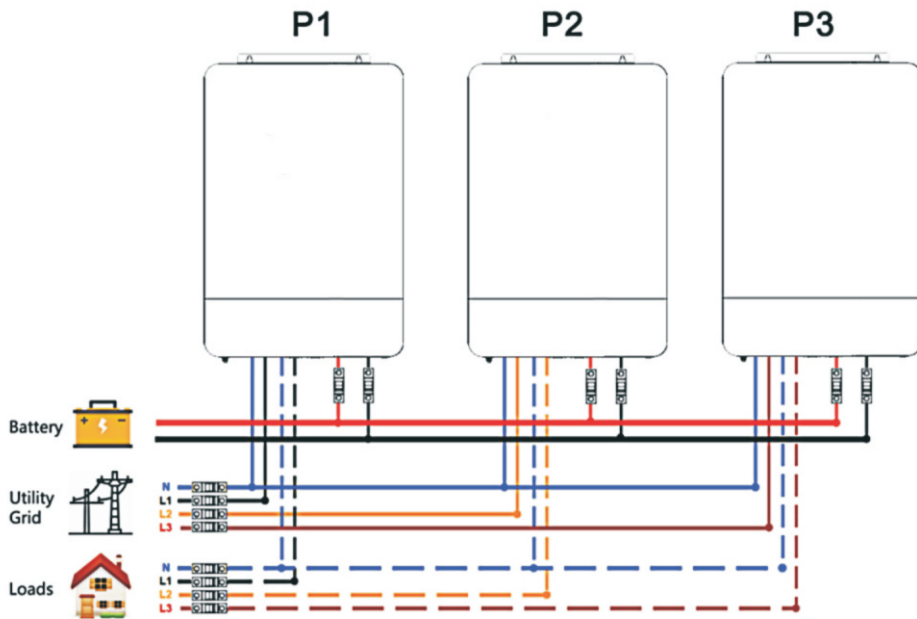

## Communication Connection

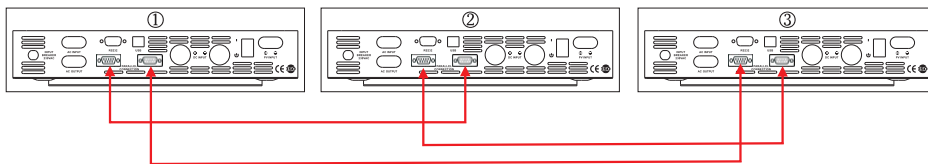

Multiple single-phase parallel systems can follow the extended wiring method of 2 single-phase parallels to three single-phase parallels.

3. Insert AC input wires according to polarities indicated on terminal block and tighten the terminal screws. Be sure to connect PE protective conductor(⊕)first.

⊕→Ground(yellow-green)

L→LINE(brown or black)

N→Neutral (blue)

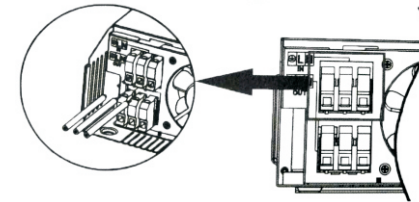

#### WARNING:

Be sure that AC power source is disconnected before attempting to hardwire it to the unit.

4. Make sure the wires are securely connected

**CAUTION:** Appliances such as air conditioner are required at least 2~3 minutes to restart because it's required to have enough time to balance refrigerant gas inside of circuits. If a power shortage occurs and recovers in a short time, it will cause damage to your connected appliances. To prevent this kind of damage, please check manufacturer of air conditioner if it's equipped with time-delay function before installation. Otherwise, this inverter/ charger will trig overload fault and cut off output to protect your appliance but sometimes it still causes internal damage to the air conditioner.

### 4.6 PV Connection

#### PV Connection(Only apply for the model with solar charger)

**CAUTION:**Before connecting to PV modules, please install **separately** a DC circuit breaker between inverter and PV modules.

**WARNING!** All wiring must be performed by a qualified personnel.

**WARNING!** It's very important for system safety and efficient operation to use appropriate cable for PV module connection. To reduce risk of injury, please use the proper recommended cable size as below.

Typical Amperage	Gauge	Torque Value
60A	3AWG	1.4~1.6Nm

#### PV module selection:

When choosing the right PV module, be sure to first consider the following requirements:

The open circuit voltage (Voc) of the PV modules does not exceed the maximum PV array open circuit voltage of the inverter. The maximum supply voltage of the PV modules should be close to the optimal PV access voltage range of the inverter for best performance. If one PV module cannot meet this requirement, it is necessary to connect multiple PV modules in series.

Model	1012P	2024P	3024M	3524M	3024MH	3524MH	5048MH	5548M	10048MH
PV Charging mode	PWM	PWM	MPPT	MPPT	MPPT	MPPT	MPPT	MPPT	MPPT Dual MPPT
MAX. PV Input power	600W	1200W	1500W	1500W	4000W	4000W	5500W	5500W	2*5500W
MPPT Tracking range	N/A	N/A	30~145Vdc	30~145Vdc	120~500Vdc	120~500Vdc	120~500Vdc	120~500Vdc	120~500Vdc
Best voltage	15~30V	30~32V	30~115V	30~115V	300~400V	300~400V	300~400V	300~400V	300~400V
MAX. PV Input Voltage	55Vdc	80Vdc	150Vdc	145Vdc	500Vdc	500Vdc	500Vdc	500Vdc	500Vdc
MAX. PV Charging current	50A	50A	60A	60A	120A	120A	100A	100A	160A
MAX. AC Charging current	50A	50A	60A	60A	120A	120A	100A	100A	160A
MAX. Charging current	100A	100A	120A	120A	120A	120A	100A	100A	160A

### PV Module Wire Connection

Please follow below steps to implement PV module connection:

1. Remove insulation sleeve 10 mm for positive and negative conductors.
2. Suggest to put bootlace ferrules on the end of positive and negative wires with a proper crimping tool
3. Fix wire cover to the inverter with supplied screws as shown in below chart.

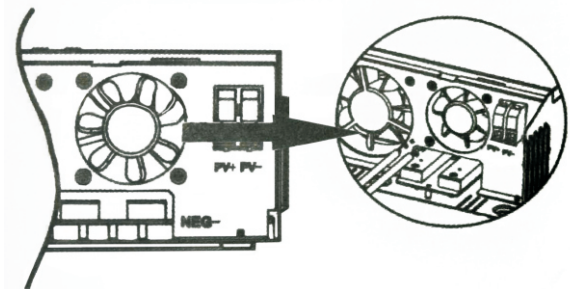
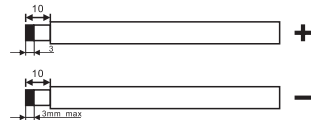

4. Check correct polarity of wire from PV modules and PV input connectors. Then, connect positive pole (+) of connection wire to positive pole (+) of PV input connector. Connect negative pole (-) of connection wire to negative pole (-) of PV input connector. Screw two wires tightly in clockwise direction. Recommended tool: 4mm blade screwdriver.

## Appendix: Parallel Operation Guide

### 1. Parallel operation

Note:

1. Before paralleling, each machine needs to calibrate the inverter output voltage, DC component, and battery voltage. In theory, The more accurate the calibration, the better, but at least meet the inverter output voltage and battery voltage calibration deviation within  $\pm 0.3V$ , DC component calibration within  $\pm 50mV$ .

2. The shutdown state, that is, the standby state, refers to the state in which the inverter has no output, but the LCD screen is on.

The method of entering standby state: when the switch is closed, quickly turn on and then immediately (1 second) turn off, then the inverter enters the standby state.

#### 1.1 Single-phase parallel operation

##### 1.1.1 Two inverters in parallel

System Connection

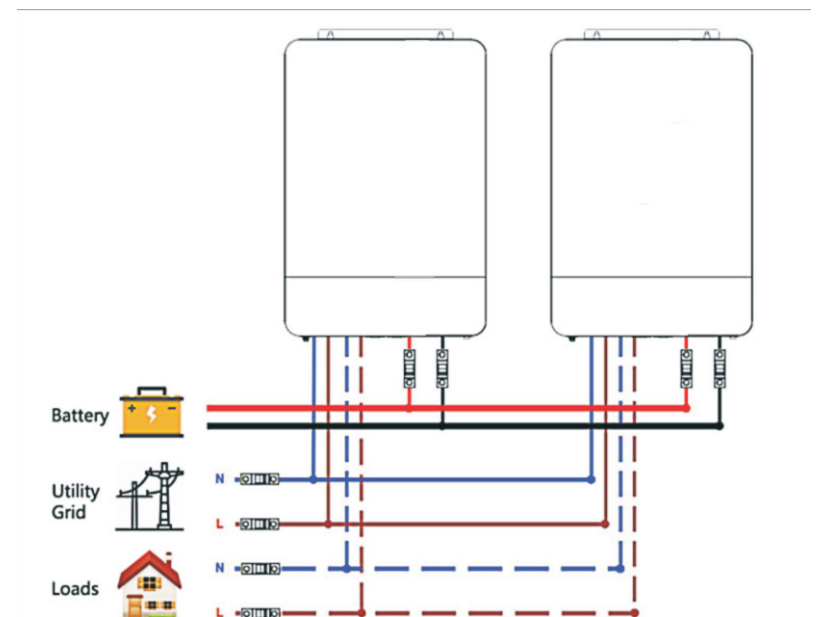

## 7. Technical datasheet

Model		1012P	2024P	3024M	3524M	3024MH	3524MH	5048MH	5548MH	10048MH	
Input	Input Sources	L+N+PE									
	Rated Input Voltage	208/220/230/240VAC									
	Voltage Range	154-264VAC±3V(APP Mode)185-264VAC±3V(UPS Mode)									
	Frequency	50Hz/60Hz(Auto Adaptive)									
Output	Rated Capacity	1000W	2000W	3000W	3500W	3000W	3500W	5000W	5500W	10000W	
	Output Voltage	208/220/230/240VAC±5%									
	Output Frequency	50/60Hz±0.1%									
	Waveform	Pure Sine Wave									
	Transfer Time (adjustable)	Computers(UPS Mode)10ms. Appliance(APP Mode)20ms									
	Peak Power	2000VA	4000VA	6000VA	7000VA	6000VA	7000VA	10000VA	11000VA	20000VA	
	Over Load Ability	Battery Mode: 1min@102%~110% Load 10s@110%~130% Load 3s@130%~150% Load 200ms@>150% Load									
	Peak Efficiency (battery Mode)	>93%	>93%	>94%	>94%	>94%	>94%	>94%	>94%	>94%	
	Battery	Battery Voltage	12Vdc	24Vdc	24Vdc	24Vdc	24Vdc	24Vdc	48Vdc	48Vdc	48Vdc
		Constant Charging Voltage(Adjustable)	4.1Vdc	28.2Vdc	28.2Vdc	28.2Vdc	28.2Vdc	28.2Vdc	56.4Vdc	56.4Vdc	56.4Vdc
Floate Charging Voltage(Adjustable)		3.5Vdc	27Vdc	27Vdc	27Vdc	27Vdc	27Vdc	54Vdc	54Vdc	54Vdc	
Chargers	PV Charging Mode	PWM	PWM	MPPT	MPPT	MPPT	MPPT	MPPT	MPPT	MPPT Dual MPPT	
	MAX.PV Input Power	600W	1200W	1500W	1500W	4000W	4000W	5500W	5500W	2*5500W	
	MPPT Tracking Range	N/A	N/A	30~145Vdc	30~145Vdc	120~500Vdc	120~500Vdc	120~500Vdc	120~500Vdc	120~500Vdc	
	Best voltage	15~30V	30~32V	30~115V	30~115V	300~400V	300~400V	300~400V	300~400V	300~400V	
	MAX.PV Input Voltage	55Vdc	80Vdc	150Vdc	145Vdc	500Vdc	500Vdc	500Vdc	500Vdc	500Vdc	
	MAX.PV Charging Current	50A	50A	60A	60A	120A	120A	100A	100A	160A	
	MAX.AC Charging Current	50A	50A	60A	60A	120A	120A	100A	100A	160A	
MAX.Charging Current	100A	100A	120A	120A	120A	120A	100A	100A	160A		
Display	LCD Display	Display Running Mode/Loads/Input/Output etc.									
Interface	RS232	5PIN/Pitch2.0mm, Baud Rate2400									
	Communication Port	2×5PIN/Pitch2.54mm,Lithium Lattery BMS Communication Card, WifiCard,DryContact									
	Parallel Connect Interface	Without Parallel Connect				With Parallel					
Environments	Operating Temperature	0~40℃									
	Humidity	20%~95%(Non-condensing)									
	Storage Temperature	-15~60℃									
	Altitude	Altitude Not Over 1000m,Derating over 1000m,Max 4000m, Refer to IEC62040									
	Noise	≤50db									

## 4.7 Final Assembly

After connecting all wirings, please put bottom cover back by screwing two screws as shown below.

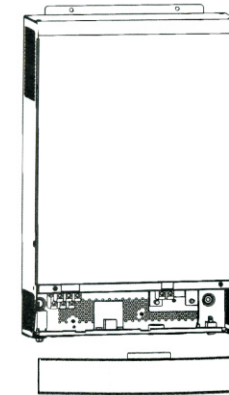

## 4.8 Communication Connection

1. Please use supplied communication cable to connect to inverter and PC. Insert bundled CD into a compute and follow on-screen instruction to install the monitoring software. For the detailed software operation. please check user manual of software inside of CD.

2. Wi-Fi cloud communication(option):

please use supplied communication cable to connect to inverter and Wi-Fi module. Download APP and installed from APP store, and Refer to "Wi-Fi Plug Quick Installation Guideline" to set up network and registering. The inverter status would be shown by mobile phone APP or webpage of computer.

3. GPRS cloud communication(option):

please use supplied communication cable to connect to inverter and GPRS module, and then applied external to GPRS module. Download APP and installed from APP store, and Refer to" GPRS RTU Quick Installation Guideline" to set up network and registering. The inverter status would be shown by mobile phone APP or webpage of computer.

## 5 OPERATION

### 5.1 Power ON/OFF

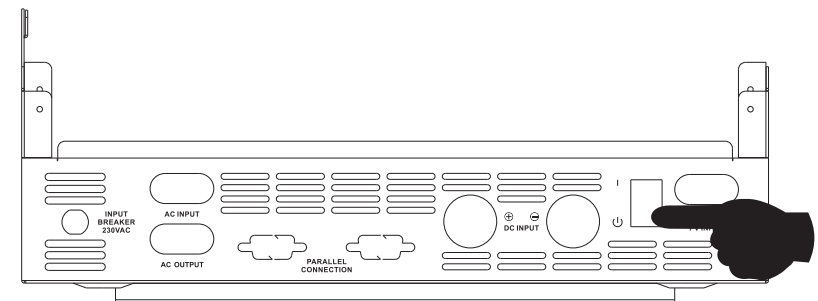

Once the unit has been properly installed and the batteries are connected well, simply press On/Off switch (located on the button of the case) to turn on the unit.

### 5.1.1 Steps to start up

Connect the battery that meets the requirements (battery voltage needs to be beyond 23V) or AC (AC needs to confirm the suitable input range depend on the output mode), then you can start up the inverter.

#### ➤ Mains power on

Connect to normal AC power, press the switch, the system will automatically turn on. If you set AC output power priority, after waiting for a period of time, the panel will display AC mode that represents turn on the machine successfully, then will enter the AC mode.

When the normal mains power is connected and press the power-on button then the system will automatically power on. If it is set as AC output priority, after a period of time, the panel will display the AC mode to indicate that the power-on is complete and enter the AC mode.

#### ➤ Battery boot

Connect to battery, press the power-on button to establish a working power source.

The system will automatically turn on, after waiting for a period of time, the panel will display battery mode that represents turn on the machine successfully, then will enter the battery mode.

### 5.1.2 Shutdown steps

When the system is in battery mode or AC mode output, press the switch again, then the system will be turned off.

## 5.2 Operation and Display Panel

### Four Function Buttons:

The operation and display panel, shown in below chart, is on the front panel of the inverter. It includes three indicators, four function buttons and a LCD display, indicating the operating status and input/output power information.

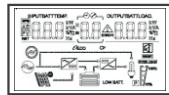

➔ LCD Display

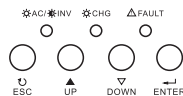

➔ LED Indicators  
➔ Function buttons

### Three Function Buttons:

The operation and display panel, shown in below chart, is on the front panel of the inverter. It includes four indicators, three function buttons and a LCD display, indicating the operating status and input/output power information.

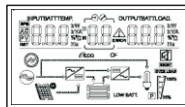

➔ LCD Display

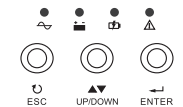

➔ LED Indicators  
➔ Function buttons

## 6 TROUBLE SHOOTING

Problem	LCD/LED/Buzzer	Explanation Possible cause	What to do
Unit shuts down automatically during startup process	LCD/LEDs and buzzer will be active for 3 seconds and then complete off.	The battery voltage is too low (<1.91v/Cell)	1. Recharge battery 2. Replace battery
No response after power on.	No indication	1. The battery voltage is far too low. (<1.4V/Cell) 2. Internal fuse tripped.	1. Contact repair center for replacing the fuse. 2. Recharge battery 3. Replace battery
Mains exist but the unit works in battery mode.	Input voltage is displayed as on the LCD and green LED is flashing	Input protector is tripped	Check if AC breaker is tripped and AC wiring is connected well.
	Green LED is flashing	Insufficient quality of AC power. (Shore or Generator)	1. Check if AC wires are too thin and/or too long. 2. Check if generator (if applied) is working well or if input voltage range setting is correct. (UPS↔Appliance)
	Green LED is flashing	Set "SBU" as the priority of output source	Change output source priority to Utility first.
When the unit is turned on, internal relay is switched on and off repeatedly.	LCD display and LEDs are flashing	Battery is disconnected	Check if battery wires are connected well.

Alarm Code	English meaning	Inverter action	Recovering conditions	Alarm Warning
52	Battery low	Warning, battery not charging	Recoverable (action point + 0.2v/piece)	Alarm
53	Battery charge short	Alarm, low battery shutdown or no engine startup	Unrecoverable	Alarm
54	Low watt discharge	Warning	Recoverable (battery voltage higher than 13. 2V/cell)	Alarm
55	Over charge	Alarm, no charging	Recoverable MPPT non charging: 29V (high voltage point - 2V); MPPT charging: high voltage point - 2V	Alarm
56	BMS Loss	Alarm, lock standby mode	recoverable	Alarm
57	Over temperature	Alarm, no charging	The temperature sensor of PFC or INV is lower than 90℃	Alarm
58	Fan lock	Alarm, If one fan fails, the other fan rotates at full speed	Recoverable	Alarm
59	EEPROM fail	Alarm	Unrecoverable	Alarm
60	Overload warning	Alarm, no charging	Reduce the load lower than 97%	Alarm
61	Abnormal generator waveform	Alarm, keep working in battery mode	Recoverable	Alarm
62	Weak energy from PV (For 5KVA high PV voltage type)	Turn off the PV output and charging	recover after 10 mins	Alarm
63	Synchronization signal fail	Alarm, switch to failure mode	Switch to stand-alone mode recovery Disconnect Troubleshooting Recovery	Alarm
64	Parallel configuration incompatible	Alarm, switch to standby mode	Resume when three-phase setting is correct	Alarm
65	Parallel version incompatible	Alarm, switch to standby mode	Restore when all machine versions in a parallel system are compatible with each other	Alarm
66	Parallel Communication Fault	Alarm, switch to standby mode	In the parallel system, it is detected that the slave machine is connected and then recovered, and it is set to stand-alone mode to recover	Alarm
67	Parallel Line Differ	Warning	Recover when it detects that the mains voltage and frequency errors of each machine are reasonable	Alarm
68	SOC Under	Alarm, switch to standby mode	Turn off the low SOC shutdown function, or turn off the BMS communication function, or recover when the SOC returns to the set value + 5%	Alarm
69	SOC Low	Alarm, if it is in standby mode, it will remain in standby mode and not turn on	Turn off the low SOC shutdown function, or turn off the BMS communication function, or recover when the SOC returns to the set value + 10%	Alarm

### 5.2.1 Buttons function

Buttons	Descriptions
Function settings /ENTER	Function settings: Press the ENTER button on the display page for more than 2 seconds to enter the function setting page. After entering, press the ENTER button to turn the page and select the interface to be set.
Page turning / inquiry button UP/DOWN	Page turning: Press UP/DOWN on any page to turn the pages.
ESC	After setting up a single item, press ESC and then press UP/DOWN to select other settings. Confirm and save settings: On the function settings page, press ESC for 2 seconds, and then go back to the main interface and set to save.

### 5.2.2 LED indicator functions

#### Three Indicators:

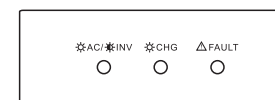

LED Indicator		Messages	
AC / INV	Green	Solid On	Output is powered by utility in Line mode.
		Flashing	Output is powered by battery or PV in battery mode.
CHG	Green	Solid On	Battery is fully charged.
		Flashing	Battery is charging.
FAULT	Red	Solid On	Fault occurs in the inverter.
		Flashing	Warning condition occurs in the inverter.

#### Four Indicators:

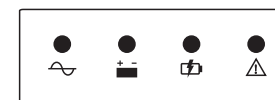

Indicator lights	Name	Descriptions
LED-G	Input light (Green)	On: the AC is normal and enters the AC to work. Flash: the AC is normal, but does not enter the AC to work Off: the AC is abnormal
LED-Y	Invert (Yellow)	On: machine working in battery mode output Off: other states
LED-Y	Battery (Yellow)	On: the battery is float charging Flash: battery charging off at constant voltage Off: other states
LED-R	Warning (Red)	On: inverter fault Flash: inverter has alarm Off: The inverter is normal



### 5.2.3 Inverter working state table corresponding to indicator lamp

Warning buzzer	Descriptions
Long beeping, continuous for 10 seconds then stop.	Failure Mode
Stop after beeping for 3 seconds	Loss or recovery of PV/input voltage
	The main switch is on or off
Beep per second, continuous for 1 min then stop	All other alarms (battery low voltage alarm will only beep in battery mode.)

### 5.2.4 Checking Parameter Operation

Under normal circumstances, there are ten pages in the display. Press the query button UP/DOWN to draw a page for the display, and display information such as input-output voltage input-output rate, battery, PV electricity and electricity, negative and component versions, etc. If there is an alarm, a page of alarm information will be displayed, and if the inverter fails, a page of trouble code will be displayed. By default, the main panel displays the fault information. When the transformer has no fault or fault, the main page displays the voltage and rate information by default.

Press UP/DOWN for more than 1 second, and LCD will enter polling mode display: automatically turn the page of display every 2 seconds, and long press UP/DOWN key again to exit polling mode.

**Display page 1 (main display page):** display the inverter input and output voltage, as shown in Figure 1-1.

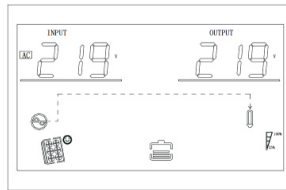

Figure 1-1 display page 1

**Display Page 2:** Display the input and output frequency of the inverter, as shown in Figure 1-2.

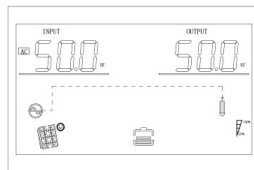

Figure 1-2 display page 2

### 5.5.1 Faults Descriptions

➤ **Fault:** The inverter enters the fault mode, the red LED light is always on and the LCD displays the fault code.

#### Fault code descriptions

Fault code	English meaning	Recovering conditions	Alarm warning
1	Bus soft start fail	Unrecoverable	Fault
2	Bus high	Unrecoverable	Fault
3	Bus low	Unrecoverable	Fault
4	Battery Over Current	Unrecoverable	Fault
5	Over temperature	Unrecoverable	Fault
6	Battery high	Recoverable Not charging: 29V (high voltage point -2V); Charging: high voltage point -2V	Fault
7	Bus soft Fault	Unrecoverable	Fault
8	Bus short Fault	Unrecoverable	Fault
9	INV soft Fault	Unrecoverable	Fault
10	INV over voltage	Unrecoverable	Fault
11	INV under voltage	Unrecoverable	Fault
12	INV short circuit	Unrecoverable	Fault
13	Negative power	Unrecoverable	Fault
14	Overload fault	Unrecoverable	Fault
15	ModelFault	Unrecoverable	Fault
16	No boot loader	Unrecoverable	Fault
17	Panel Flash Fault	Recoverable after Flash	Fault
19	Same Serial	Unrecoverable	Fault
20	CAN Fault	Unrecoverable	Fault
21	BAT Volt Different	Unrecoverable	Fault
22	Line Volt Different	Unrecoverable	Fault
23	Line Freq Different	Unrecoverable	Fault
24	Output Config Different	Recover when set to stand-alone operation or meet the three-phase operation setting conditions	Fault
25	Output Syn Loss	Unrecoverable	Fault
26	BMS Fault	Close the BMS communication function, or BMS failure recovery	Fault

### 5.5.2 Warning Descriptions

➤ **Alarm:** The red LED flashes, and the LCD displays an alarm code, the inverter does not enter the failure mode

#### Alarm code descriptions

Alarm Code	English meaning	Inverter action	Recovering conditions	Alarm Warning
50	Battery not connected	Alarm, no charging	Battery voltage $\geq 10V \cdot n$	Alarm
51	Low battery shutdown	Alarm, battery low voltage shutdown or unable to boot	Auto-restart when battery voltage more then $(10V + 0.2V) \cdot N$ , N for numbers of battery serial group.	Alarm



However, in Equalize stage, when battery equalized time is expired and battery voltage doesn't rise to battery equalization voltage point, the charge controller will extend the battery equalized time until battery voltage achieves battery equalization voltage. If battery voltage is still lower than battery equalization voltage when battery equalized timeout setting is over, the charge controller will stop equalization and return to float stage.

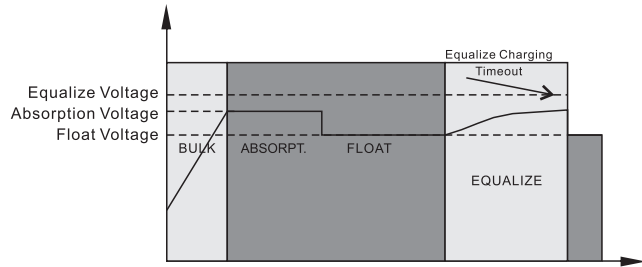

### 5.5 Fault and alarm description



Figure 1-58 Fault and warning icons

**Function description:** The alarm code ALA flashes and the buzzer beeps once for 1s and stops after 1 minute. The fault indicator code is always on, the buzzer beeps for 10 seconds and then stops. After the fault is stopped and the fault is eliminated, Then try to restart the inverter. If the restart fails for three times, it will continue to be in the fault state.

The fault and alarm LCD display is as shown in the figure above, the fault icon in the fault mode is always on, and the alarm icon in the alarm state flashes. Kindly contact the manufacturer to eliminate the abnormal condition according to the fault information.

**Display page 3:** battery information, showing battery voltage and battery capacity and charging current, as shown in Figure 1-3.

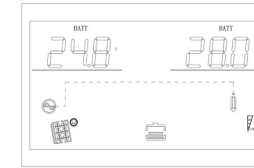

Figure 1-3 display page 3

**Display page 4:** PV info, display PV voltage and PV charging amps, as shown in Figure 1-4.

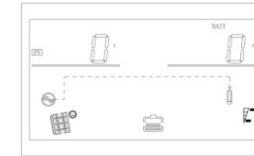

Figure 1-4 display page 4

**Display page 5:** PV info, display PV voltage and PV charging wattage, show as 1-5.

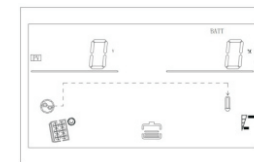

Figure 1-5 display page 5

**Display page 6:** Output Information shows the output voltage and output power, as shown in Figure 1-6.

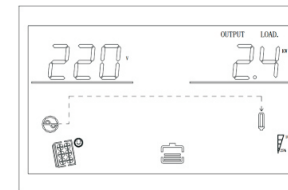

Figure 1-6 display page 6

**Display page 7:** Output Information shows the output voltage and output power, as shown in Figure 1-7

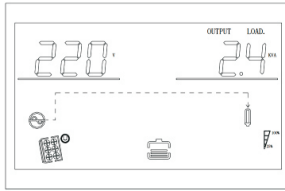

Figure 1-7 display page 7

**Display page 8:** Output Information displays output voltage and load percentage, as shown in Figure 1-8.

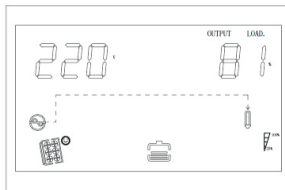

Figure 1-8 display page 8

**Display page 9:** Software version displays the inverter system software version, as shown in Figure 1-9( Software Version VER 01)

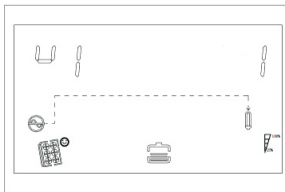

Figure 1-9 display page 9

**Display page 10:** The left side of the page information displays the total power generation, and the right side displays the current power generation, as shown in Figure 1-10.

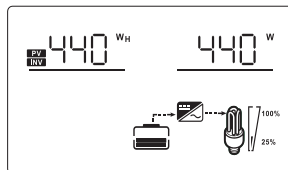

Figure 1-10 display page 10

#### 5.4 Battery Equalization Description

Equalization function is added into charge controller, It reverses the buildup of negative chemical effects like stratification, a condition where acid concentration is greater at the bottom of the battery than at the top. Equalization also helps to remove sulfate crystals that might have built up on the plates. If left unchecked, this condition, called sulfation, will reduce the overall capacity of the battery. Therefore, it's recommended to equalize battery periodically.

##### ※ How to Apply Equalization Function

You must enable battery equalization function in monitoring LCD setting program 30 first. Then, you may apply this function in device by either one of following methods:

1. Setting equalization interval in program 35.
2. Active equalization immediately in program 36.

##### ※ When to Equalize

In stage, when the setting equalization interval( battery equalization cycle) is arrived, or equalization is active immediately, the controller will start to enter Equalize stage.

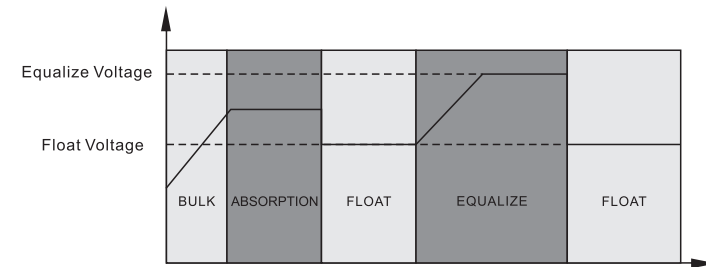

##### ※ Equalize charging time and timeout

In Equalize stage, the controller will supply power to charge battery as much as possible until battery voltage raises to battery equalization voltage. Then, constant-voltage regulation is applied to maintain battery voltage at the battery equalization voltage. The battery will remain in the Equalize stage until setting battery equalized time is arrived.

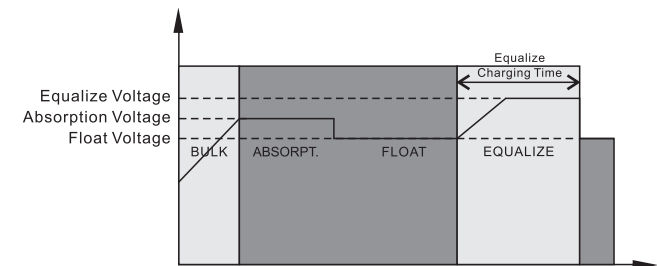

**Function description:** Set the SOC value of the inverter to battery mode.

**Setting conditions:**All states can be set.

**Explanation:**

STG:Battery SOC turn to battery mode.

The default setting is 90, and the settable range is [10,100]. PBG priority mains normal mains mode, switch to battery mode when the lithium battery SOC reaches the set value. After it is turned on, the inverter will switch to battery mode only when the SOC is higher than the set point and the battery voltage is higher than the voltage point for switching back to battery mode (see 1.4.2.15).

It can be set to OFF. At this time, the inverter will no longer switch from mains mode to battery mode according to the SOC.

After the function is enabled, if a communication abnormality occurs, the inverter no longer determines the operation logic based on the SOC information, and clears the relevant alarm.

\*This function needs to be used in conjunction with the central control board.

\*When the central control board is not connected, this option page is blocked.

#### 5.3.40 Low SOC transfer function (STG)

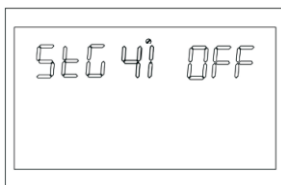

Figure 1-57 Low SOC to mains function setting page

**Function description:** Set the SOC value of the inverter to the mains mode.

**Setting conditions:** All states can be set.

**Explanation:**

STG:Battery SOC turn to grid mode.

The default setting is 50, and the settable range is [10,90]. PBG priority Mains normal battery mode Switch to mains mode when the lithium battery SOC reaches the set value. After it is turned on, when the SOC is lower than the set point or the battery voltage is lower than the return-to-mains voltage point (see 1.4.2.14), the inverter will switch to the mains mode.

It can be set to OFF. At this time, the inverter will no longer switch from battery mode to mains mode according to the SOC.

After the function is enabled, if a communication abnormality occurs, the inverter no longer determines the operation logic based on the SOC information, and clears the relevant alarm.

When this setting is higher than the STB point, STB and STG will not take effect after the next time they take effect.

\*This function needs to be used in conjunction with the central control board.

\*When the central control board is not connected, this option page is blocked.

**Display page 11:** Display information. In single unit mode, the LCD shows status of single unit mode both on the left and right sides.

In parallel connect mode, the LCD shows the master slave relation on the left, shows the parallel status on the right. If parallel connect as three phases use, the LCD shows the phase position on the left, shows the status on the right. Shown in Figure 1-12 (applicable to the Inverter with parallel function)

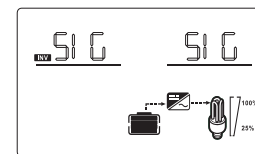

Figure 1-11 display page 11

**Display page 12:** Lithium battery networking status; when the upper right display is a constant SIG, the battery pack is running in a single group; when it is displayed as a PAR constant, the battery pack is running in multiple series and parallel; when the display is PAR flashing, the battery pack is being established Multiple series and parallel state.

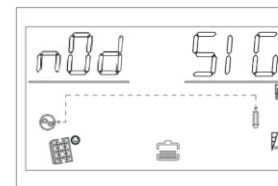

Figure 1-12 Display page 12  
(lithium battery network status)

**Display page 13:** lithium battery voltage and current information; the upper left display is BMS battery voltage information; the upper right display is BMS battery current information. When the BMS communication fails, the upper left and right upper displays are flashing ERR.

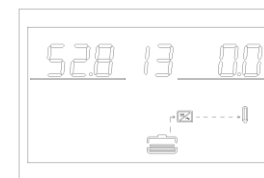

Figure 1-13 Display page 13  
(lithium battery voltage and current information)

**Display page 14:** Lithium battery temperature, SOC; the upper left display is BMS temperature information; the upper right display is BMS SOC information. When the BMS communication fails, the upper left and right upper displays are flashing ERR.

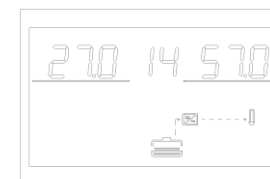

Figure 1-14 Display page 14  
(battery temperature, SOC information of lithium battery)

**Display page 15:** lithium battery capacity; the upper left display is the rated capacity; the upper right display is the current capacity. When the BMS communication fails, the upper left and right upper displays are flashing ERR.

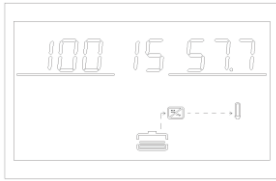

Figure 1-15 Display page 15  
(battery capacity information of lithium battery)

**Display page 16:** Lithium battery constant voltage point; the upper left display is the fixed letter CV; the upper right display is the BMS constant voltage charging point. When the BMS communication fails, the upper right displays a flashing ERR.

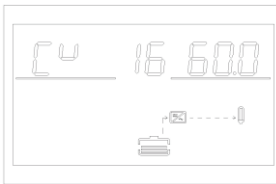

Figure 1-16 Display page sixteen  
(lithium battery constant voltage information)

**Display page 17:** Lithium battery failure alarm information; the upper left display is BMS alarm information; the upper right display is BMS failure information. When the BMS communication fails, the upper left and right upper displays are flashing ERR.

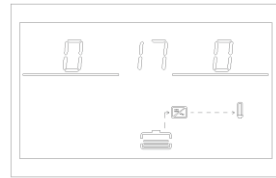

Figure 1-17 Display page seventeen  
(Lithium battery fault warning information)

**Function description:** Set whether the inverter communicates with the lithium battery BMS.

**Setting conditions:** All states can be set.

**Explanation:**

BMS: Battery Manage System

The default setting is OFF, and the function is not enabled; when it is set to ON, the inverter communicates with the lithium battery BMS through the central control board and obtains battery information.

After the function is enabled, if a communication abnormality occurs, an alarm 56 will be generated, and the inverter will no longer determine the operation logic based on the BMS information.

\*This function needs to be used in conjunction with the central control board.

\*When the central control board is not connected, this option page is blocked.

### 5.3.38 Low SOC shutdown function (SBU)

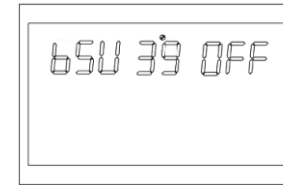

Figure 1-55 Low SOC shutdown function setting page

**Function description:** Set the inverter to shut down when the SOC is low.

**Setting conditions:** All states can be set.

**Explanation:**

BSU: Battery SOC (capacity) under lock

The default setting is 20, and the settable range is [5,50]. In battery mode, when the SOC of the lithium battery reaches the set value, it will shut down and alarm 68 will be issued at the same time, and the alarm 68 will be cleared when it returns to the set value + 5%. When in standby mode, it will switch to battery mode only when it reaches the set value + 10%, and it will alarm 69 if it is not reached. After the function is turned on, when the SOC of the lithium battery reaches the set value + 5%, the alarm 69 will be issued, and the alarm 69 will be cleared when it returns to the set value + 10%.

It can be set to OFF. At this time, the inverter will no longer perform shutdown, startup, and alarm operations according to the SOC situation.

After the function is enabled, if a communication abnormality occurs, the inverter no longer determines the operation logic based on the SOC information, and clears the relevant alarm.

\*This function needs to be used in conjunction with the central control board.

\*When the central control board is not connected, this option page is blocked.

### 5.3.39 High SOC to battery function (STB)

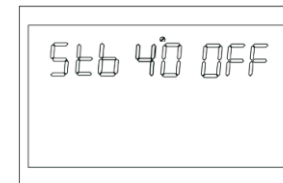

Figure 1-56 Low SOC to mains function setting page

### 5.3.35 Battery Dual Output Low Voltage Shutdown Point (DBV)

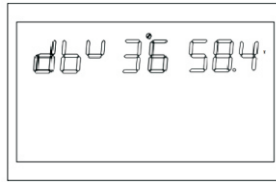

Figure 1-52 Battery dual output low voltage shutdown point page

**Function description:** When enabled, the secondary output of the inverter is enabled by default. After entering the battery mode, when the battery voltage is lower than the set point, the secondary output is turned off. When the battery voltage is higher than the set value + 1V/cell again, the secondary output is turned on.

**Setting conditions:** All states can be set.

**Explanation:**

DBV: Dual output battery mode cut-off voltage

3k-VML-24V/3K-VP-24V The default setting is 24V, and the setting range is [22,32]

The default setting of 5k-VMH-48V is 48V, and the setting range is [44,60]

When the set point is higher than the constant voltage charging (CV) point - 1V/knot, the constant voltage charging point is used as the recovery voltage.

\*This function needs to be used in conjunction with the dual output auxiliary board.

### 5.3.36 Battery Dual Output Duration (DBT)

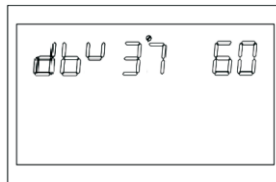

Figure 1-53 Battery dual output low voltage shutdown point page

**Function description:** When enabled, the secondary output of the inverter is enabled by default. After entering the battery mode, when the battery discharge time reaches the set point, the secondary output will be turned off.

**Setting conditions:** all states can be set.

**Explanation:**

DBT: Dual output battery mode cut-off time

The default setting is OFF, the function is not enabled, the setting range is [5,890], and the unit is minute. When it is set to FUL, the output time of the secondary output is not limited.

\*This function needs to be used in conjunction with the dual output auxiliary board.

### 5.3.37 BMS communication function (BMS)



Figure 1-54 BMS management function setting page

## 5.3 Function setting operation

### ➤ Function setting operation:

The page for setting the exit function and setting as bellow:

- Long press “ENTER” button for more than 2 seconds, enter into function setting mode. Press “Enter” button to choose function, turn the page to you need to set, the corresponding indicator will flash.

- Press “ Enter ” button again, enter the function setting, you will see the word of function you choose lighting, on the left of word will occur numerical flashing, then you can press “ UP/DOWN ” button to use.

- After finish setting, press the enter button again, the data will be on instead of flashing.

Long press “ ESC ” button for more than 2 seconds, the function will complete setting. Return to function setting, then back to main page. ( If you don't exit manually, after 30 seconds, it will be back to main page automatically ).

### 5.3.1 Output Voltage (OPU)



Figure 1-18 Output Voltage Setting

- The default output voltage is 230V, 208V, 220V, 230V, 240V can be set, all working conditions can be set, and it will take effect immediately.

- Press the function setting key “ENTER” key for more than 2 seconds to enter the function setting page, press the query key “UP/DOWN” key for 0.1 to 2 seconds to select the function, after turning the page to the output voltage PU setting page, the word OPU flashes.

- Press the “ENTER” key for 0.1 to 2 seconds to enter the setting page of the output voltage OPU. At this time, the word OPU is long on, and the value flashes to the right of the word OPU. Press the query key “UP/DOWN” key for 0.1 to 2 seconds to select different output voltage values, the available voltage values are 208V, 220V, 230V, 240V. By default, the output voltage is 230V, and the settings are saved in real time.

- After turning the page to the desired output voltage value, press the “ENTER” key for 0.1~2 seconds, the output voltage PU setting is completed, and the value on the right side of the OPU will be long on and no longer flashing.

- Press the “ESC” key for more than 0.1 to 2 seconds, the function will be set successfully, exit the function setting page, and return to the main display page (or do not operate, and automatically jump back to the main display page after waiting for up to 30S).

**Note:**

When the output voltage is set to 208V, the output needs to be derated to 90%.

### 5.3.2 Output frequency

Output frequency setting, the default value is 50Hz.

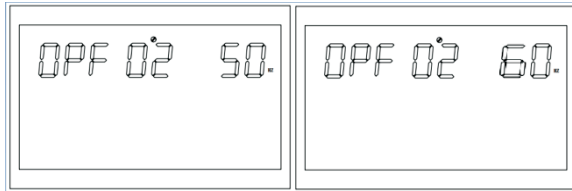

Figure 1-19 Output Frequency Setting Page

**Function description:** 50Hz or 60Hz can be adjusted, default value is 50Hz.

**Setting conditions:** All states can be set. In battery mode, the setting will take effect when the Inverter is restarted next time; in mains mode, it will take effect immediately. After the setting is completed, after switching back to battery mode, the frequency will change at a slower rate.

### 5.3.3 Output priority settings



Figure 1-20 Output priority settings page

**Function description:** Set the inverter output priority.

**Setting conditions:** All states can be set, and they will take effect immediately after setting.

**Note:**

There are three options for output priority, the default is GRD: mains output priority; the second is PU(PV): photovoltaic output priority; the third is PBG: PV first, battery second, mains third output;

### 5.3.4 Output Mode Settings (MOD)

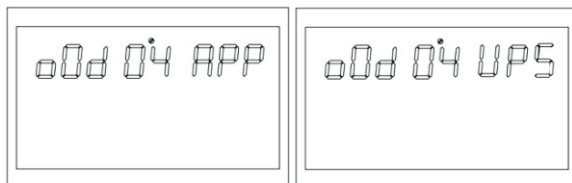

Figure 1-21 Output mode setting page

### Function description: Equalization Delay Time Settings

**Setting conditions:** Can be set in all states

**Explanation:**

EQT: Equalization Timeout

In the equalization stage, when the cell equalization time expires and the cell voltage does not rise to the cell equalization voltage point, the charge controller will extend the cell equalization time until the cell voltage reaches the cell equalization voltage. When the battery balancing delay setting ends, the battery voltage is still lower than the battery balancing voltage, the charge controller will stop balancing and return to the floating charge stage.

The default setting is 120 minutes, the settable range is [5,900], and the increment is 5 minutes each time.

### 5.3.33 Equalization interval setting (EQI)

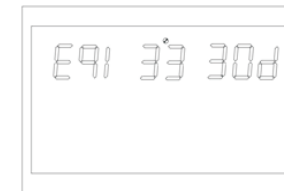

Figure 1-50 Equalization interval setting

**Function description:** Equalization interval setting

**Setting conditions:** Can be set in all states

**Explanation**

EQI:Equalization interval

When the battery connection is detected during the float phase with the equalization mode turned on, the controller will start to enter the equalization phase when the set equalization interval (cell equalization period) is reached.

The default setting is 30 days, the settable range is [1,90], and the increment of each setting is 1 day.

### 5.3.34 Turn on equalization settings immediately

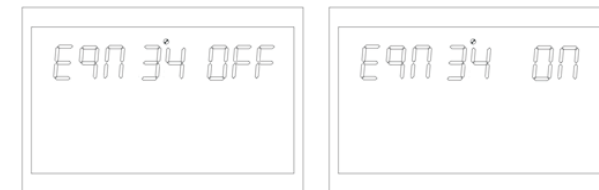

Figure 1-51 Turn on equalization settings immediately

**Function description:** Turn on equalization settings immediately

**Setting conditions:** Can be set in all states

**Explanation:**

EQN:Equalization Now

The default setting is OFF, the function is not turned on; when it is set to ON, in the float charging stage when the balance mode is turned on and the battery connection is detected, the balance charging is activated immediately, and the controller will start to enter the balance stage.



### 5.3.30 Equalization voltage point setting (EQV)



Figure 1-47 Equalization voltage point setting page

**Function description:** Equilibrium voltage point setting function

**Setting conditions:** Can be set in all states

**Explanation:**

bCV:Equalization Voltage

Can be set in all states

3k-VML-24V The default setting is 29.2, and the settable range is [25, 31.5]

5k-VMh-48V The default setting is 58.4, and the settable range is [48, 60].

### 5.3.31 Equalization charging time setting (EQT)



Figure 1-48 Equalization charging time setting(page)

**Function description:** Equalization charging time setting

**Setting conditions:** Can be set in all states

**Explanation:**

EQT:Equalization Time

During the equalization phase, the controller will charge the cells as much as possible until the cell voltage rises to the cell equalization voltage. Then use constant voltage regulation to maintain the battery voltage to maintain the battery balance voltage. The cells will remain in the equalization phase until the set cell equalization time is reached.

The default setting is 60 minutes, the settable range is [5,900], and the increment is 5 minutes each time.

### 5.3.32 Equalization Delay Time Settings (EQO)



Figure 1-49 Equalization Delay Time Settings Page

**Function description:** Set the inverter output mode.

**Setting conditions:** All states can be set and take effect immediately.

**Explanation:**

There are two options for AC output mode, the default is APP: Appliance which is used for home appliances; the second is UPS mode, which is used for computers and other equipment. The switching time is typically 10ms.

### 5.3.5 Charging priority settings (CHP)



Figure 1-22 Charging priority setting page

**Function description:** Set the inverter charging priority.

**Setting conditions:** All states can be set and take effect immediately.

**Explanation:**

There are four options for charging priority, the default is PNG (PV and Grid): PV and Grid are charged at the same time; the second is OPV (Only PV): only photovoltaic charging; the third is GRD (Grid): mains charging priority The fourth is PV: PV priority charging.

### 5.3.6 Mains charging current (RCC)

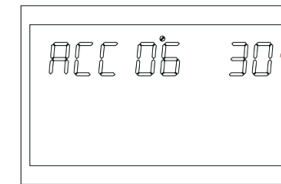

Figure 1-23 Mains maximum charging setting page

**Function description:** Set the maximum charging current of the inverter mains.

**Setting conditions:** All states can be set.

**Explanation:**

RCC: Grid Charge Current, the default setting of the maximum charging current of the mains is 40A, and the setting range is [1, 60A] (for 3KV24V, 150V MPPT Version)

RCC: Grid Charge Current, the default setting of the maximum charging current of the mains is 30A, and the setting range is [1, 80A] ( for 5KV-48V-500V MPPT Voltage Version)

### 5.3.7 Maximum charging current (MCC)

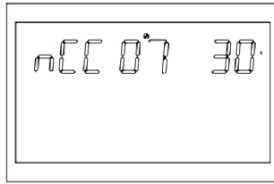

Figure 1-24 Maximum charging current setting page

**Function description:** Set the maximum charging current value of the inverter.

**Setting conditions:** All states can be set.

**Explanation:**

**MCC:** Maximum Charge Current, the maximum charging current refers to the maximum value of the PV and mains charging current.

3KV 150V-MPPT Version is 2/10/20/30/40/50/60/70/80/90/100/110/120A optional;

5KV-48V-500V MPPT Voltage version is 2/10/20/30/40/50/60/70/80/100A optional;

### 5.3.8 Menu Front (MDF)

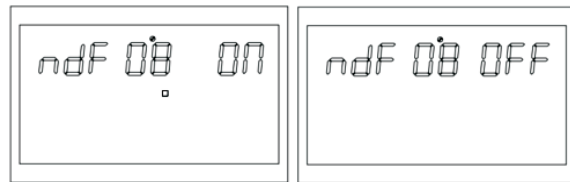

Figure 1-25 Return to the home page setting page

**Function description:** Return to the main interface settings.

**Setting conditions:** All states can be set.

**Explanation:**

The default setting is ON. In the function setting operation, when it is set to ON, if the page is not in the first interface (P1) at this time, it will return to the first interface after 1 minute; if it is set to OFF, if the page is not in the first interface (P1) at this time, the LCD will Always stay on this interface.

### 5.3.9 Overload restart setting (LrS)

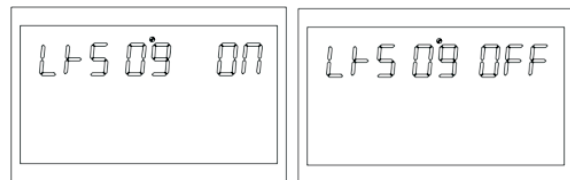

Figure 1-26 Overload restart setting page

**Function description:** Overload restart setting.

**Setting conditions:** All states can be set.

**Explanation:**

Overload restart is set to ON by default.

**Explanation:**

MOD:Operation mode.

The default set is SIG (single mode) Standalone mode, it can be set as PAR (parallel mode) Single-phase parallel mode, P1 (R phase mode), 3P2 (S phase mode), 3P3 (T phase mode)

When using the parallel function, first connect the parallel system in the correct way, and then set the parallel mode of each machine correctly. If there is a machine set to SIG in the parallel system, the machine reports fault 24. If there are machines set to 3P1, 3P2, 3P3 in the parallel system, all machines must be set to one of these three modes, and at least one machine exists in each mode, otherwise all the machines set to these three modes must be set to one of the three modes. The machine reports fault 24.

Mains mode and standby mode can be set and take effect immediately, but cannot be set in battery mode and cannot be displayed in pictures

### 5.3.28 Missing battery alarm (SBA)



Figure 1-45 Missing battery alarm page

**Function description:** Set turn on no battery alarm

**Setting conditions:** Can be set in all states

**Explanation:**

SBA:Set battery alarm.

Default is OFF

If it is set to OFF, when the battery is not connected, there will be no battery-missing, low-battery, and under-battery alarms.

### 5.3.29 Equalization Mode (EQM)



Figure 1-46 Equalization Mode Settings Page

**Function description:** Setting whether the inverter turn on equalization mode

**Setting conditions:** Can be set in all states

**Explanation:**

EQM:Equalization Mode

The default setting is OFF, the function is not turned on; if it is set to ON, the controller will start to enter the equalization phase when the set equalization interval (battery equalization period) is reached during the float charging stage, or the equalization is activated immediately.

### 5.3.25 Inverter soft start setting (SRE)

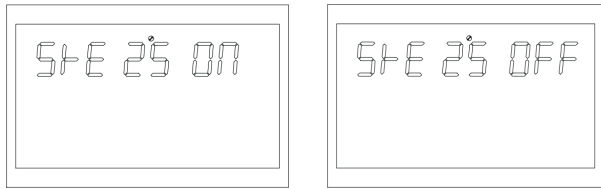

Figure 1-42 Inverter soft start setting page

**Function description:** When the setting is ON, the inverter output gradually increases from 0 to the target voltage point. This function is very suitable for the motor and the loads with motor. When the setting is OFF, the inverter output is directly increased from 0 to the target voltage point.

**Setting conditions:** at all states can be set.

**Explanation:**

**SRE:** Soft Relay Enable

The default setting is OFF, and the output switch will not be closed until the inverter voltage rises to the rated output. If set to On, the output switch will be closed before the inverter starts boosting.

### 5.3.26 Reset factory settings (SED)

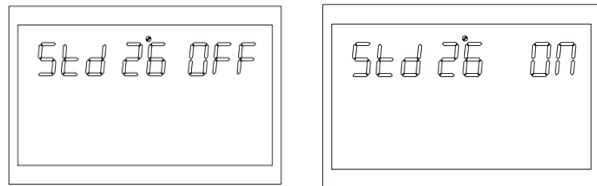

Figure 1-43 Default value settings page

**Function description:** Restore all setting to factory settings.

**Setting conditions:** It can be set in mains mode and StandBy (no output but screen on state). It cannot be set when the battery mode.

**Explanation:**

**SED:** Set Default

Before the setting, this interface is displayed as OFF. When it is set to ON, the system will restore to factory settings. After the setting is completed, this interface will display OFF again.

### 5.3.27 Parallel Mode Settings (MOD)



Figure 1-44 Parallel Mode Settings page

**Function description:** Setting parallel working mode.

**Setting conditions:** Mains Mode and Standby (StandBy: No output but screen turn on) can be set. It cannot be set in battery mode.

### 5.3.10 Over temperature restart setting (TrS)

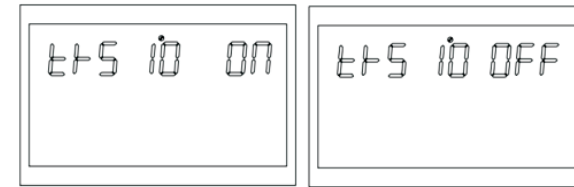

Figure 1-27 Over temperature restart setting page

**Function description:** Over-temperature restart settings.

**Setting conditions:** All states can be set.

**Explanation:**

The default setting for over-temperature restart is ON.

### 5.3.11 Main input power failure alarm setting (MIP)

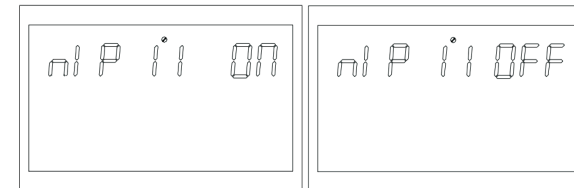

Figure 1-28 Main input power failure alarm setting page

**Function description:** Mains or PV loss alarm long beep setting

**Setting conditions:** All states can be set, the default is ON, and the mains or PV loss alarm will beep for a while. Can be set to OFF. (All modes can be set)

**Explanation:**

**MIP:** Main input cut warning

The default setting is ON, after the main input detection is lost, the buzzer will sound for 3s; when it is set to OFF, after the main input is lost, the buzzer will not sound constantly.

### 5.3.12 Power Saving Mode (PWS)

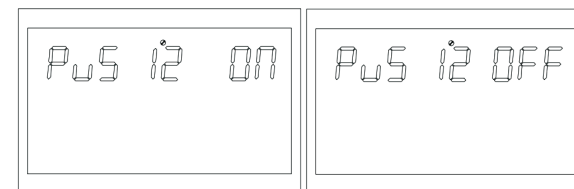

Figure 1-29 Power Saving Mode Setting Page

**Function description:** Set whether the inverter enables low power consumption mode (energy saving mode).

**Setting conditions:** All states can be set.

**Explanation:**

**PWS:** Power Saving

The default setting is OFF, the function is not turned on; when it is set to ON, in battery mode, if the load is lower than 25W, the system will temporarily stop the output, and then continue to output. If the load is higher than 35W, the system will resume continuous normal output.

### 5.3.13 Overload convert to bypass setting (OLG)

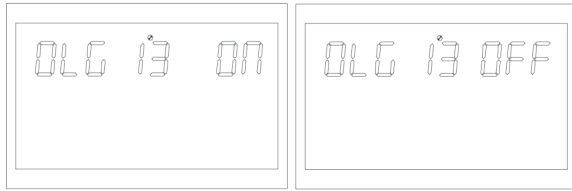

Figure 1-30 Overload convert to bypass setting page

**Function description:** When overload in the battery mode, set whether to switch to the mains mode (bypass mode) immediately.

**Setting conditions:** All states can be set.

**Explanation:**

**OLG:**Over load to Bypass

The default setting is OFF, the function is not enabled; when it is set to ON, under the condition of PV priority output with load, if overloaded, the system will immediately transfer to bypass (mains output, namely bypass mode).

### 5.3.14 Silent mode setting

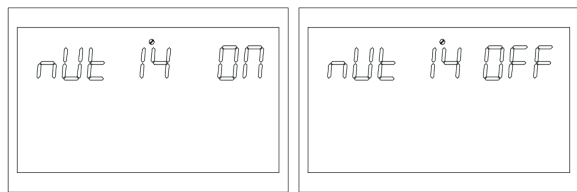

Figure 1-31 Silent mode setting page

**Function description:** Set whether the buzzer beeps or not.

**Setting conditions:** All states can be set.

**Explanation:**

**MUE** Mute

The default setting is OFF, and the function is not turned on; when it is set to ON, the buzzer does not sound under any circumstances, such as alarms, faults, etc. All modes can be set and function normally, pictures cannot be displayed.

### 5.3.15 Battery mode to mains mode voltage point

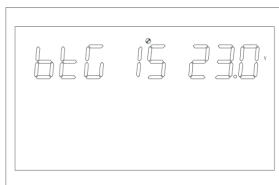

Figure 1-32 Battery mode to mains mode voltage point setting page

In inverter mode (output mode: MOD needs to be set to APP), the low-voltage point of mains is set, the default setting is 154V, and the setting range is [90, 154]. (Output mode: MOD needs to be set to UPS), the low-voltage point setting of mains, the default setting is 185V, and the setting range is [170, 200].

### 5.3.23 Mains high voltage protecting point setting (LHV)



Figure 1-40 Mains high voltage protecting point setting page in APP mode

**Function description:** Set the mains high voltage protection point.

**Setting conditions:** The inverter is in APP mode, and all states can be set.

**Explanation:**

**LHV:**Line High Voltage

In inverter mode (output mode: MOD needs to be set to APP), the mains high voltage point setting, the default setting is 264V, and the setting range is [264, 280].

### 5.3.24 Low power discharging time setting (LWD)

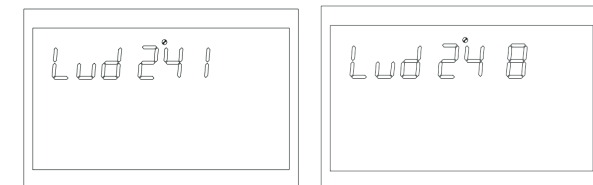

Figure 1-41 Low power discharging time setting page

**Function description:** Low power discharge protection function, when in battery mode, under a low load, the discharge of unlimited time will make the battery empty and affect the battery life. When the inverter is in the low power discharge setting time, the low voltage shutdown point of the 3KVA-24Vdc -150V-MPPT model battery will increase to 22V. 5KVA-48Vdc-500V-MPPT model battery low voltage shutdown point will be raised to 44V.

**Setting conditions:** All states of the inverter can be set in APP mode.

**Explanation:**

**LWD :** Low Watt Discharge

In inverter mode, the low power discharge time setting, the default is 8 (8 hours), the setting range is [1, 8]

In battery mode, after the continuous discharge time exceeds 8 hours and the battery shutdown point has not been reached, the battery voltage shutdown point will be modified to 11V \* number of battery cells, and the system will alarm for 1 minute when the battery continues to discharge to 11V \* number of battery cells. Then shut down again.

When the battery voltage exceeds 13.2V\* the number of battery cells exceeds 30s, the battery discharge time will be reset.

### 5.3.21 Floating charge mode voltage point setting (bFL)

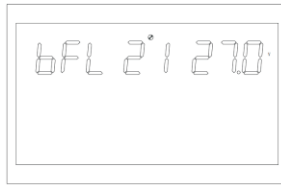

Figure 1-38 Floating charge mode voltage point setting page

**Function description:** Float voltage point setting function.

**Setting conditions:** All states can be set.

**Explanation:**

**bFL :** battery Float

Set the battery type to cUS (customer set type) to modify the battery floating point.

The default setting of 3KVA-24Vdc-150V-MPPT model is 27.6V, and the setting range is [26.6, 27.8].

The constant voltage point voltage needs to be higher than the floating point voltage.

The default setting of 5KVA-48Vdc-500V-MPPT model is 54V, and the setting range is [48,60]. The constant voltage point voltage needs to be higher than the floating point voltage.

The constant voltage charging point can be modified when the battery type is set to LIB (lithium battery type).

The default setting of 3KVA-24Vdc-150V-MPPT model is 27.6V, and the setting range is [24, 28].

The constant voltage point voltage needs to be higher than the floating point voltage.

The default setting of 5KVA-48Vdc-500V-MPPT model is 55.2V, and the settable range is [50, 58].

The constant voltage point voltage needs to be higher than the floating point voltage.

### 5.3.22 Mains low voltage point setting (LLV)

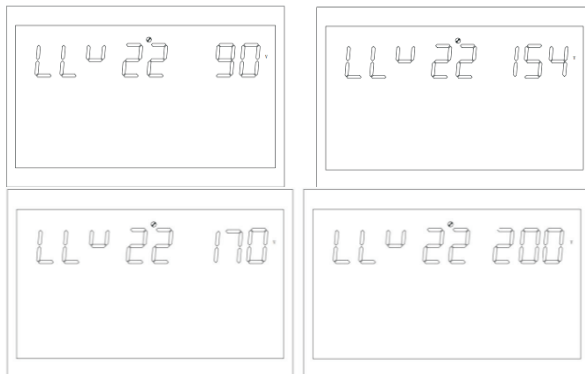

Figure 1-39 Mains low voltage point setting page in APP mode

**Function description:** Set the mains low voltage protection point.

**Setting conditions:** The inverter is in APP and UPS mode, all states can be set

**Explanation:**

**LLV:**Line Low Voltage

**Function description:** When the battery and mains exists at the same time, the battery will be transferred to the mains when it is discharged to a certain voltage to ensure that the battery will not be empty.

**Setting conditions:** All states can be set, and the output priority should be set in PV or PBG modes.

**Explanation:**

**BTG: Back To Grid**

When the battery definition mode is CUS (customer set type) mode:

The default setting of 3KVA-24Vdc-150V-MPPT model is 23v, and the settable range is [22, 26].

The default setting of 5KVA-48Vdc-500V MPPT model is 46V, and the settable range is [44, 52].

When the battery definition mode is AGM (lead-acid battery type), FLD (water injection battery type) mode:

3KVA-24Vdc-150V MPPT model default setting is 23v, and the settable range is [22, 26].

The default setting 5KVA-48Vdc-500V-MPPT model is 46V, and the settable range is [44, 52].

When the battery definition mode is LIB (lithium battery type) mode:

The default setting of 3KVA-24Vdc-150V MPPT model is 23.8v, and the settable range is [20, 25].

The default setting of 5KVA-48Vdc-500V MPPT model is 47.6V, and the settable range is [40, 50].

### 5.3.16 Switch back to battery mode voltage point (BTB)

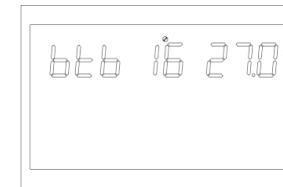

Figure 1-33 Setting of battery voltage point when mains switch back to battery mode

**Function description:** After the battery is turned off at low voltage, it needs to reach a certain battery voltage value before it can be restarted in battery mode.

**Setting conditions:** All states can be set.

**Explanation:**

**BTB: Back To Battery**

When the battery definition mode is CUS (customer set type) mode:

The default setting of 3KVA-24Vdc-150V-MPPT model is 26V, and the settable range is [24, 29] (when the setting value Vbtb>26V, the voltage point of switching back to battery mode remains at 26V), and the output priority is set to photovoltaic (PV priority output Or photovoltaic battery mains (PBG output, if it is not in battery mode at this time, if the battery voltage is higher than 26V, the system will switch back to battery mode.

The default setting of 5KVA-48Vdc-500V-MPPT model is 54V, and the settable range is [48,58] (the logic is the same as above)

When the battery definition mode is AGM (lead-acid battery type), FLD(water injection battery type) mode:

3KVA-24Vdc-150V-MPPT model default Set to 26V, the settable range is [24, 29] (the logic is the same as above).

5KVA-48Vdc-500V-MPPT model default setting is 52v, the settable range is [48,58] (the logic is the same as above)

The battery definition mode is LIB (lithium battery type) mode:

The default setting of 3KVA-24Vdc-150V-MPPT model is 27.2v, and the settable range is [23, 29] (the logic is the same as above).

The default setting of 5KVA-48Vdc-500V-MPPT model is 54.4V, and the settable range is [46,58] (the logic is the same as above).

### 5.3.17 Battery mode setting



Figure 1-34 Battery mode setting page

**Function description:** battery type setting function

**Setting conditions:** All states can be set.

**Explanation:**

**BAT:**Battery Type

Four battery type settings: the default setting is AGM (lead-acid battery); the second is FLD (water injection battery); the third is LIB (lithium battery); the fourth is Cus (customer setting type).

### 5.3.18 Battery low voltage point

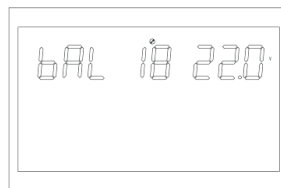

Figure 1-35 Battery low voltage point setting

**Function description:** Low voltage alarm point setting.

**Setting conditions:** All states can be set.

**Explanation:**

**bAL:** battery Low

The battery low voltage point can be modified when the battery type is set to CUS (customer set type). 3KVA-24Vdc-150V-MPPT model is set to 22v by default, and the settable range is [21, 27] 5KVA-48Vdc-500V-MPPT model is set to 44V by default, and the settable range is [ 42, 54] When the battery type is set to LIB (lithium battery type), the battery low voltage point can be modified. The default setting of 3KVA-24Vdc-150V-MPPT model is 23.8v, the settable range is [20.6, 25.0] The default setting of 5KVA-48Vdc-500V-MPPT model is 47.6V, and the settable range is [41.2, 50.0]

### 5.3.19 Battery low voltage cut off point

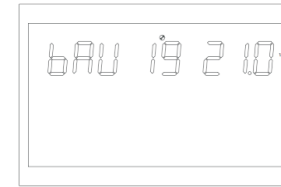

Figure 1-36 Battery low voltage cut off point setting page

**Function description:** Battery low voltage shutdown point setting function.

**Setting conditions:** All states can be set.

**Explanation:**

**bAU:** battery Under

The battery shutdown point can be modified when the battery type is set to CUS (customer set type). The default setting of 3KVA-24Vdc-150V-MPPT model is 21V, and the setting range is [20,24] The default setting of 5KVA-48Vdc-500V-MPPT is 42V, and the settable range is [40,48] The battery shutdown point can be modified when the battery type is set to LIB (lithium battery type). 3KVA-24Vdc-150V-MPPT model is set to 23V by default, and the settable range is [20,24] The default setting of 5KVA-48Vdc-500V-MPPT model is 46V, and the setting range is [40, 48]

### 5.3.20 Constant voltage mode voltage point setting (bCV)



Figure 1-37 Constant voltage mode voltage point setting page

**Function description:** Constant voltage point setting function

**Setting conditions:** All states can be set

**Explanation:**

**bCV :** battery Constant Voltage

The constant voltage charging point can be modified when the battery type is set to CUS (customer set type).

The default setting of 3KVA-24Vdc-150V-MPPT model is 28.2, and the setting range is [24,29]. The constant voltage point voltage needs to be higher than the floating point voltage.

The default setting of 5KVA-48Vdc-500V-MPPT model is 56.4, and the settable range is [48,60] . The constant voltage point voltage needs to be higher than the floating point voltage.

The constant voltage charging point can be modified when the battery type is set to LIB (lithium battery type).

The default setting of 3KVA-24Vdc-150V-MPPT model is 28.2, and the setting range is [25,29]. The constant voltage point voltage needs to be higher than the floating point voltage.

The default setting of 5KVA-48Vdc-500V-MPPT model is 56.4, and the setting range is 48,56] . The constant voltage point voltage needs to be higher than the floating point voltage.